

7" Modero X[®] Series G5 Wall Mount Touch Panel

MXD-701-L (FG5968-55) Landscape Wall Mount Touch Panel

MXD-701-P (FG5968-54) Portrait Wall Mount Touch Panel



Overview

The MXD-701 / 7" Modero X[®] Series G5 Wall Mount Touch Panel is a premium user interface that includes the G5 graphics engine and delivers superior performance. Designed for dedicated room control or scheduling, this elegantly-styled touch panel provides fast and smooth animations and transitions, along with a quad-core processor that provides more than enough processing power to run the most demanding applications today and in the future. The MXD-701 also includes a built-in web browser and document viewers, enabling users to access real-time information during meetings or lectures.

The MXD-701 is built for usability, offering edge-to-edge capacitive touch glass with multi-touch capabilities. The distinctive appearance will complement even the most sophisticated meeting facilities and homes, with a variety of mounting options for added security and convenience.

Common Applications

- The MXD-701 is ideal for boardrooms, conference rooms or auditoriums where a premium control surface is needed to provide access to multiple functions simultaneously while remaining elegantly unobtrusive.

- In Higher Education, the MXD-701 is ideal for lecture halls, auditoriums, performing arts theaters and boardrooms that require extensive control capabilities.
- In residences, it is perfect for kitchens, bedrooms or home offices where it can be used to manage systems throughout the home.
- The MXD-701 can be used as a scheduling panel for high-end meeting rooms and auditoriums.
- All Modero X Series Wall Mount panels are ideal for reception areas or other gathering places where master calendars can be displayed along with streamed information from the web like weather and stock quotes.

Features

- **G5 Graphics Engine and Quad Core Processing** – The most powerful processing in the industry delivers smooth gesturing, swiping, dynamic reordering, enhanced animation with transitions all at higher speeds for an experience any user will enjoy
- **Simplified Enterprise Touch Panel and Firmware Updates** – Deploy and update touch panel files and firmware files from a network URL for simplified company-wide updates
- **Built-in Web Browser, Document Viewers and Enzo Sharing** – Conveniently simplifies accessing and presenting real-time content and documents during meetings. Simply preview files accessed via the native web browser, USB, or cloud storage apps before sending content directly to Enzo. An upcoming firmware release will allow apps to be updated or disabled using the onboard G5 App Update Manager.
- **Adjustable Security Modes** – With the ability to select from high security or custom modes, administrators can customize the panel’s security levels for access, networking and communication.
- **Perfect From Any Angle** – Includes In-Plane Switching (IPS), which delivers the widest viewing angles and the most accurate color reproduction on the market
- **Enhanced User Experience** – The Modero X Series features intuitive UI functionality including: gesturing, swiping, dynamic reordering and enhanced animation capabilities
- **Generous Mounting Options** – In addition to wall mount, you can mount the 7" Modero X Series Landscape Wall/Flush Mount Touch Panel directly to an equipment rack using the optional MXA-RMK-07 Modero X Series Rack Mount Kit (FG5969-63)
- **View and Select Dynamic Data with Listview Buttons** – Display a listing of entries generated by a dynamic data source (e.g. phonebook contacts, call logs, RSS feed or other real time data sources) enabling the user to scroll or search to make a selection. Demos are available in the UI Resource Center

Specifications

TOUCH SCREEN DISPLAY	
Display Type	TFT Active Matrix Color LCD with Fringe Field Switching (FFS) - Wide Viewing Angle Technology
Display Size (WH)	Landscape: 7.3" x 4.8" (186 mm x 122 mm) 8.8" (222 mm) diagonal Portrait: 4.8" x 7.3" (122 mm x 186 mm), 8.8" (222 mm) diagonal
Viewable Area (WH)	Landscape: 6.05" x 3.54" (154 mm x 90 mm) 7.0" (178 mm) diagonal Portrait: 3.54" x 6.05" (90 mm x 154 mm), 7.0" (178 mm) diagonal
Resolution (WH)	Landscape: 1024x600, Portrait: 600x1024
Aspect Ratio (WH)	Landscape: 16:9, Portrait: 9:16
Brightness	400 cd/m2
Contrast Ratio	800:1
Color Depth	16.7M colors
Illumination	LED
Touch Overlay	Projected Capacitive, multi-touch support, 3 simultaneous max
Viewing Angle	Vertical $\pm 89^\circ$, Horizontal $\pm 89^\circ$

MEMORY	
SDRAM	2 GB
Flash	16 GB
Maximum Project Size	12 GB flash, available for apps and touch panel files

COMMUNICATIONS	
ETHERNET	10/100 Auto MDI-X port, RJ-45 connector. Supported IP and IP-Based Protocols: UCP, TCP, ICMP, ICSP, IGMP, DHCP, SSH, FTP, DNS, RFB (for VNC), HTTP
USB	(2) USB host 2.0, Type A ports (1 with limited physical access requiring right angle connection): Firmware upgrade, touch panel file transfer, document and image viewing, HID peripherals
Bluetooth	Mouse/Keyboard: HID Profile v1.1, requires MXA-BT Bluetooth Adapter (FG5968-19)

VIDEO	
Supported Video Codecs	MPEG-2-TS: MPEG-2 Main Profile @High Level up to 720p at 25 fps (decode only) MJPEG up to 720p at 25 fps (decode only)
Supported Video Transport Streams	MPEG-TS for MPEG-2 and H.264; HTTP for MJPEG
Max Number of Active Video Streams	Two decode

AUDIO	
Microphone	-42dB +- 3dB sensitivity FET microphone
Speakers	4 ohm, 2 Watt, 300Hz cutoff frequency
Supported Audio Codecs	MP2 Layer I and II, MP3 (8 kHz, 11.025 kHz, 12 kHz, 16 kHz, 22.05 kHz, 24 kHz, 32 kHz, 44.1 kHz, 48 kHz) AAC-LC (8 kHz, 96 kHz) G.711 with μ Law (VoIP encode/decode at 8kHz)
File Formats	WAV, MP3 (as part of touch panel file only - no USB storage)
Intercom	Full Duplex VoIP, SIP v2.0

GRAPHICS ENGINE	
AMX G5	G5 enhanced feature set supporting multi-touch and gestures, scrolling, transitions, applications - See TPD5 Operations Guide for more information

EMBEDDED APPLICATIONS	
Viewer Applications	PDF, JPEG, BMP, PNG, TIFF, GIF, PowerPoint, .doc, .docx, .xls, .xlsx, .ppt, .pptx
Remote Management	VNC Server
Video Conferencing	Skype, the MXD-701 receives audio/video and returns audio
Audio Conferencing	Audio (full duplex intercom)

FRONT PANEL COMPONENTS	
Light Sensor	Photosensitive light detector for automatic adjustment of the panel brightness
Proximity Detector	Max range = ~3', typ range = ~1', FOV = ~10 degrees

Sleep Button	Sleep button to activate sleep mode and powering off. Also provides access to setup pages (can be disabled)
--------------	---

CONNECTIONS	
Ethernet	10/100 Auto MDI-X port, RJ-45 connector
USB	(2) USB host 2.0, Type A ports
Power	PoE (Power over Ethernet), 802.3af, class 3

ENVIRONMENTAL	
Temperature (Operating)	32° F to 104° F (0° C to 40° C)
Temperature (Storage)	4° F to 140° F (-20° C to 60° C)
Humidity (Operating)	20% to 85% RH
Humidity (Storage)	5% to 85% RH
Power ("Heat") Dissipation	On: 39.2 BTU/hr Standby: 19.8 BTU/hr

GENERAL	
Networking	Support for static/dynamic IPv4 and static IPv6
Dimensions (HWD)	Landscape: 4 13/16" x 7 5/16" x 2 1/2" (122 mm x 186 mm x 63 mm) Portrait: 7 5/16" x 4 13/16" x 2 1/2" (186 mm x 122 mm x 63 mm)
Weight	1.4 lbs (0.64 Kg)
Power Consumption	Full-On: 11.5 W maximum Standby: 5.8 W Shutdown: 1 W
Start-Up Inrush Current	Not applicable due to PoE standard
External Power Supply Required	Optimal performance requires use of one of the following AMX PoE power supplies (not included): <ul style="list-style-type: none"> • PS-POE-AF-TC, PoE Injector, 802.3AF Compliant (FG423-83) • NXA-ENET8-2POE, Gigabit PoE Ethernet Switch (FG2178-63)
Regulatory Compliance	FCC Part 15 Class B C-Tick CISPR 22 Class B CE EN 55022 Class B and EN 55024 CB Scheme IEC 60950-1 IC IEC/EN-60950 UL 60950-1 RoHS/WEEE compliant
Included Accessories	<ul style="list-style-type: none"> • MXA-USB-C, USB Port Cover Kit, Modero X/S Series Touch Panel (FG5968-18) • MXA-CLK, Modero X/S Series Cleaning Kit (FG5968-16)
Optional Accessories	<ul style="list-style-type: none"> • MXA-FMK-07 Flush Mount Kit, 7" Modero X Wall Mount (FG5968-71) • MXA-RMK-07 Modero X Series Rack Mount Kit (FG5969-63) • MXA-MP, Modero X/S Series Multi Preview (FG5968-20) • MXA-MPL, Modero X/S Series Multi Preview Live (FG5968-10) • PS-POE-AF-TC, PoE Injector, 802.3AF Compliant (FG423-83)

	<ul style="list-style-type: none">• CB-MXSA-07, Rough-In Box and Cover Plate for the 7" Wall Mount Modero X/S Series Touch and RoomBook Panels (FG039-18)• CB-MXP7, Rough-In Box, Modero X/S Series Touch Panel, 7" (FG039-18)• CB-MXP-07-F, Flush Mount Rough-In Box and Cover Plate, for use with MXA-FMK-07 Flush Mount Kit for 7" Modero X Wall Mount Touch Panels (FG5968-83)• MXA-BT Bluetooth USB Adapter for Modero X/S Series (FG5968-19)• MXA-CLK, Modero X/S Series Cleaning Kit (FG5968-16)• NXA-ENET8-2POE, Gigabit PoE Ethernet Switch (FG2178-63)• MXA-USB-C, USB Port Cover Kit, Modero X/S Series Touch Panel (FG5968-18)
--	--

For more detailed pictorial drawings please visit: <http://www.amx.com/products/MXD-701.asp>

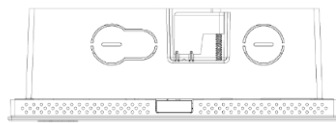
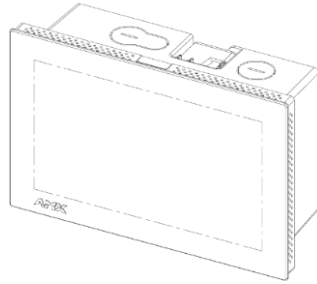
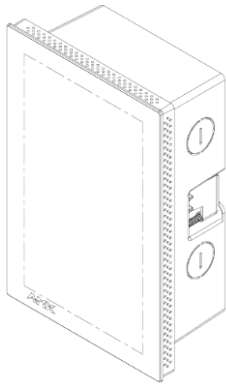

MXD-701
(Landscape - Top View)

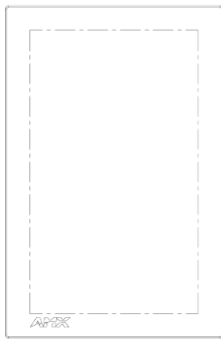

MXD-701
(Portrait - Front View)

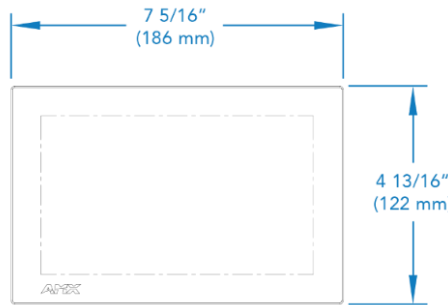

MXD-701
(Landscape - Front View)

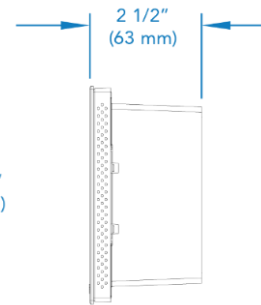

MXD-701
(Landscape - Right View)

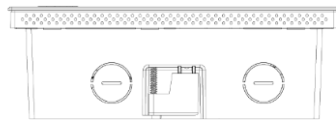

MXD-701
(Landscape - Bottom View)

About AMX by HARMAN

Founded in 1982 and acquired by HARMAN in 2014, AMX® is dedicated to providing AV solutions for an IT World. AMX solves the complexity of managing technology with reliable, consistent and scalable systems comprising control, video switching and distribution, digital signage and technology management. AMX systems are deployed worldwide in conference rooms, classrooms, network operation/command centers, homes, hotels, entertainment venues and broadcast facilities, among others. AMX is part of the HARMAN Professional Group, the only total audio, video, lighting, and control vendor in the professional AV market. HARMAN designs, manufactures and markets premier audio, video, infotainment and integrated control solutions for the automotive, consumer and professional markets. Revised 8.30.16. ©2016 Harman. All rights reserved. Specifications subject to change.

www.amx.com | +1.469.624.7400 | 800.222.0193