



HARDWARE REFERENCE MANUAL

VERSION: V1.0.6

Precis PR-Series Matrix Switcher

Precis 4K60 HDMI Switcher



AV FOR AN IT WORLD®

IMPORTANT SAFETY INSTRUCTIONS

1. READ these instructions.
2. KEEP these instructions.
3. HEED all warnings.
4. FOLLOW all instructions.
5. DO NOT use this apparatus near water.
6. CLEAN ONLY with dry cloth.
7. DO NOT block any ventilation openings. Install in accordance with the manufacturer's instructions.
8. DO NOT install near any heat sources such as radiators, heat registers, stoves, or other apparatus (including amplifiers) that produce heat.
9. DO NOT defeat the safety purpose of the polarized or grounding type plug. A polarized plug has two blades with one wider than the other. A grounding type plug has two blades and a third grounding prong. The wider blade or the third prong are provided for your safety. If the provided plug does not fit into your outlet, consult an electrician for replacement of the obsolete outlet.
10. PROTECT the power cord from being walked on or pinched, particularly at plugs, convenience receptacles, and the point where they exit from the apparatus.
11. ONLY USE attachments/accessories specified by the manufacturer.
12. USE ONLY with a cart, stand, tripod, bracket, or table specified by the manufacturer, or sold with the apparatus. When a cart is used, use caution when moving the cart/apparatus combination to avoid injury from tip-over.
13. UNPLUG this apparatus during lightning storms or when unused for long periods of time.
14. REFER all servicing to qualified service personnel. Servicing is required when the apparatus has been damaged in any way, such as power-supply cord or plug is damaged, liquid has been spilled or objects have fallen into the apparatus, the apparatus has been exposed to rain or moisture, does not operate normally, or has been dropped.
15. DO NOT expose this apparatus to dripping or splashing and ensure that no objects filled with liquids, such as vases, are placed on the apparatus.
16. To completely disconnect this apparatus from the AC Mains, disconnect the power supply cord plug from the AC receptacle.
17. Where the mains plug or an appliance coupler is used as the disconnect device, the disconnect device shall remain readily operable.
18. DO NOT overload wall outlets or extension cords beyond their rated capacity as this can cause electric shock or fire.



The exclamation point, within an equilateral triangle, is intended to alert the user to the presence of important operating and maintenance (servicing) instructions in the literature accompanying the product.



The lightning flash with arrowhead symbol within an equilateral triangle is intended to alert the user to the presence of uninsulated "dangerous voltage" within the product's enclosure that may be of sufficient magnitude to constitute a risk of electrical shock to persons.



ESD Warning: The icon to the left indicates text regarding potential danger associated with the discharge of static

electricity from an outside source (such as human hands) into an integrated circuit, often resulting in damage to the circuit.

WARNING: To reduce the risk of fire or electrical shock, do not expose this apparatus to rain or moisture.

WARNING: No naked flame sources - such as candles - should be placed on the product.

WARNING: Equipment shall be connected to a MAINS socket outlet with a protective earthing connection.

WARNING: To reduce the risk of electric shock, grounding of the center pin of this plug must be maintained.

COPYRIGHT NOTICE

AMX© 2018, all rights reserved. No part of this publication may be reproduced, stored in a retrieval system, or transmitted, in any form or by any means, electronic, mechanical, photocopying, recording, or otherwise, without the prior written permission of AMX. Copyright protection claimed extends to AMX hardware and software and includes all forms and matters copyrightable material and information now allowed by statutory or judicial law or herein after granted, including without limitation, material generated from the software programs which are displayed on the screen such as icons, screen display looks, etc. Reproduction or disassembly of embodied computer programs or algorithms is expressly prohibited.

LIABILITY NOTICE



No patent liability is assumed with respect to the use of information contained herein. While every precaution has been taken in the preparation of this publication, AMX assumes no responsibility for error or omissions. No liability is assumed for damages resulting from the use of the information contained herein. Further, this publication and features described herein are subject to change without notice.

AMX WARRANTY AND RETURN POLICY

The AMX Warranty and Return Policy and related documents can be viewed/downloaded at www.amx.com.

ESD WARNING

	<p>To avoid ESD (Electrostatic Discharge) damage to sensitive components, make sure you are properly grounded before touching any internal materials.</p> <p>When working with any equipment manufactured with electronic devices, proper ESD grounding procedures must be followed to make sure people, products, and tools are as free of static charges as possible. Grounding straps, conductive smocks, and conductive work mats are specifically designed for this purpose. These items should not be manufactured locally, since they are generally composed of highly resistive conductive materials to safely drain static discharges, with-out increasing an electrocution risk in the event of an accident.</p> <p>Anyone performing field maintenance on AMX equipment should use an appropriate ESD field service kit complete with at least a dissipative work mat with a ground cord and a UL listed adjustable wrist strap with another ground cord.</p>
--	--

	<p>CAUTION RISK OF ELECTRIC SHOCK DO NOT OPEN</p>		<p>WARNING: Do Not Open! Risk of Electrical Shock. Voltages in this equipment are hazardous to life. No user-serviceable parts inside. Refer all</p>
---	--	---	---

	servicing to qualified service personnel.
--	---

	Place the equipment near a main power supply outlet and make sure that you can easily access the power breaker switch.
--	--

WARNING: This product is intended to be operated ONLY from the voltages listed on the back panel or the recommended, or included, power supply of the product. Operation from other voltages other than those indicated may cause irreversible damage to the product and void the products warranty. The use of AC Plug Adapters is cautioned because it can allow the product to be plugged into voltages in which the product was not designed to operate. If the product is equipped with a detachable power cord, use only the type provided with your product or by your local distributor and/or retailer. If you are unsure of the correct operational voltage, please contact your local distributor and/or retailer.

FCC AND CANADA EMC COMPLIANCE INFORMATION:

This device complies with part 15 of the FCC Rules.

Operation is subject to the following two conditions:

(1) This device may not cause harmful interference, and (2) this device must accept any interference received, including interference that may cause undesired operation.

NOTE: This equipment has been tested and found to comply with the limits for a Class A digital device, pursuant to part 15 of the FCC Rules. These limits are designed to provide reasonable protection against harmful interference in a commercial environment. This equipment generates, uses and can radiate radio frequency energy and, if not installed and used in accordance with the instructions, may cause harmful interference to radio communications. However, there is no guarantee that interference will not occur in a particular installation. If this equipment does cause harmful interference to radio or television reception, which can be determined by turning the equipment off and on, the user is encouraged to try to correct the interference by one or more of the following measures:

- Reorient or relocate the receiving antenna.
- Increase the separation between the equipment and receiver.
- Connect the equipment into an outlet on a circuit different from that to which the receiver is connected.
- Consult the dealer or an experienced radio/TV technician for help.

Approved under the verification provision of FCC Part 15 as a Class A Digital Device. Caution

Changes or modifications not expressly approved by the manufacturer could void the user's authority to operate this device. CAN ICES-3 (B)/NMB-3(B)

EU COMPLIANCE INFORMATION:

Eligible to bear the CE mark; Conforms to European Union Low Voltage Directive 2006/95/EC; European Union EMC Directive 2004/108/EC; European Union Restriction of Hazardous Substances Recast (RoHS2) Directive 2011/65/EU; European Union WEEE (recast) Directive 2012/19/EU; European Union Radio and Telecommunications Terminal Equipment (R&TTE) Directive 1999/5/EC

WEEE NOTICE:

	<p>This appliance is labeled in accordance with European Directive 2012/19/EU concerning waste of electrical and electronic equipment (WEEE). This label indicates that this product should not be disposed of with household waste. It should be deposited at an appropriate facility to enable recovery and recycling.</p>
---	--

Table of Contents

IMPORTANT SAFETY INSTRUCTIONS	2
Overview	8
PR-0808	8
Features	8
Package Contents	8
Specifications	9
PR-0602	11
Features	11
Package Contents	11
Specifications	12
PR-0404	14
Features	14
Package Contents	14
Specifications	15
PR-0402	17
Features	17
Package Contents	17
Specifications	18
Panel Description	20
PR-0808 Front Panel	20
Rear Panel	20
Panel Description	21
PR-0602 Front Panel	21
Rear Panel	21
Panel Description	22
PR-0404 Front Panel	22
Rear Panel	22
Panel Description	23
PR-0402 Front Panel	23
Rear Panel	23
Installation and Wiring	24
Brackets Installation for PR-0808/0602/0404	24
Wiring	24
PR-0808/PR-0602/PR-0404	24
PR-0402	28
Front Panel Control	30
PR-0808/PR-0602/PR-0404	30
PR-0402	30
PR-0808/PR-0602/PR-0404 LCM Menu	31
RS232 Operation	32

WebGUI Control	34
Identify the IP address of the PR-0808/PR-0602/PR-0404	34
Identify the IP address of the PR-0402	34
Access the Web Interface	34
Web Interface Introduction	34
Security	36
Switcher	38
System	41
Firmware Upgrade	43
Before Starting	43
Firmware Upgrade through WebGUI	43
Firmware Upgrade through USB	43
Troubleshooting	44
Appendix: API Command List Instructions	45
System Commands	45
Network Commands	49
Security Commands	52
Configuration Commands-Input	54
Configuration Commands-Output	59
Switching Commands	65

Overview

PR-0808

The AMX PR-0808 provides the ability to connect up to eight 4K UHD+ HDMI sources to up to eight 4K UHD+ HDMI displays and freely switch between them. This unit comes with full support for 18Gbps resolutions up to, and including 4K@60Hz (4:4:4, 8-bit) as well as support for Deep Color, HDR (High Dynamic Range), HD audio and other features defined by the HDMI 2.0 specification. With a comprehensive EDID management feature that includes the ability to select between built in EDIDs, EDIDs copied from connected sink devices, as well as user provided EDIDs, this matrix can solve many interconnectivity problems.

Features

- HDMI Inputs and Outputs support up to 4K@60Hz 4:4:4 8bit
- Fully compliant with HDMI 2.0
- HDCP 2.2 compliant
- Supports 4K HDR
- Supports audio de-embedding for each HDMI output
- Supports IPv4 & IPv6 networks, support HTTPS, SSH
- Supports PCM 2-Channel, PCM Multi-Channel, Dolby Digital, Dolby Digital Plus, Dolby Atmos, Dolby True HD, DTS, DTS HD MA

Package Contents

- 1 x PR-0808
- 1 x 12V/7.5A DC Power Adapter
- 1 x AC Power Cable with US Pins
- 1 x AC Power Cable with UK Pins
- 1 x AC Power Cable with EU Pins
- 9 x 3-Pin Terminal Blocks
- 2 x Mounting Ears
- 6 x Mounting Screws

Specifications

Technical	
Input	8 x HDMI IN
Input Resolution Supported	<p>VESA:</p> <p>640x480 @ 60, 72, 75 Hz</p> <p>720 x 400 @ 70, 85 Hz</p> <p>800 x 600 @ 56, 60, 72, 75, 85 Hz</p> <p>848 x 480 @ 60 Hz</p> <p>1024 x 768 @ 60, 70, 75, 85 Hz</p> <p>1152 x 864 @ 75 Hz</p> <p>1280 x 768 @ 60 Hz, 75 Hz</p> <p>1280 x 800 @ 60 Hz (Reduce Blanking)</p> <p>1280 x 960 @ 60 Hz</p> <p>1280 x 1024 @ 60, 85 Hz</p> <p>1360 x 768 @ 60, 75, 85 Hz</p> <p>1366 x 768 @ 60 Hz (Reduce Blanking)</p> <p>1400 x 1050 @ 60 Hz (Reduce Blanking), 75 Hz</p> <p>1440 x 900 @ 60 Hz (Reduce Blanking), 75, 85 Hz</p> <p>1600 x 900 @ 60 Hz (Reduce Blanking)</p> <p>1600 x 1200 @ 60 Hz</p> <p>1680 x 1050 @ 60 Hz (Reduce Blanking)</p> <p>1920 x 1200 @ 60 Hz (Reduce Blanking)</p> <p>1920 x 1200 @ 60 Hz</p> <p>1920 x 1440 @ 60 Hz</p> <p>2048 x 1080 @ 50, 60 Hz</p> <p>2560 x 1440 @ 60 Hz (Reduce Blanking)</p> <p>2560 x 1600 @ 60 Hz (Reduce Blanking)</p> <p>3840 x 2160 @ 60 Hz (Reduce Blanking)</p> <p>CEA Information Code (VIC) Formats:</p> <p>720 x 480i @ 59.94, 60 Hz</p> <p>720 x 576i @ 50 Hz</p> <p>720 x 480p @ 59.94, 60 Hz</p> <p>720 x 576p @ 50 Hz</p> <p>1280 x 720p @ 50, 59.94, 60 Hz</p> <p>1920 x 1080i @ 50, 59.94, 60 Hz</p> <p>1920 x 1080p @ 24, 25, 29.97, 30, 50, 59.94, 60 Hz</p> <p>2560 x 1080p @ 50, 60 Hz</p> <p>3840 x 2160p @ 24, 25, 29.97, 30, 50, 59.94, 60 Hz</p> <p>4096 x 2160p @ 24, 25, 29.97, 30, 50, 59.94, 60 Hz</p>

Input Audio Supported	PCM 2-Channel, PCM Multi-Channel, Dolby Digital, Dolby Digital Plus, Dolby Atmos, Dolby True HD, DTS, DTS HD MA
Output	8 x HDMI Out
Output Resolution Supported	Same as the Input
Analog Audio Output Level (Max)	+1.6 dB, unbalanced; ≥ 2 kohm load
Analog Audio Output Frequency Response	< -0.5 dB to +0.2 dB, 30 Hz to 20 kHz or < -0.8 dB to +0.2 dB, 20 Hz to 20 kHz
Analog Audio Output THD+N	<0.006%, 1 kHz, -10 dB to +2 dB
Analog Audio Output SNR	>102 dB, 20 Hz to 20 kHz $V_{in} = +2$ dB
Maximum Data Rate	18Gbps
Control Method	Front panel, IR, RS232 and Web GUI

General	
Operating Temperature	32F (0°C) to 104F (40°C)
Storage Temperature	-4°F (-20°C) to 140°F (60°C)
Humidity	5% to 90% (RH (non-condensing))
Power Supply	Voltage, DC: 12V/7.5A
Power Consumption (Max)	73.6W
EDS Protection	Human-body Model: ± 10 kV(Air-gap discharge)/ ± 5 kV(Contact discharge)
Device Dimension (W x H x D)	10.59 x 18.97 x 1.73
Product Weight	Approx. 7.9 lbs
Certification	FCC Part 15 Class B EN 55032 EN 55035 CB IEC/EN 60950 CB IEC/EN 62368-1 UL 62368-1 RoHS/REACH EMC (Australia) EMC (Canada) EMC (UKCA) Prop65

Transmission Distance

Note: Straight-through Ethernet cable of T568B is recommended.

General	Range	Supported Video
HDMI Output	15m/49ft	1080P@60Hz
	10m/33ft	4K@60Hz 4:2:0
	5m/16ft	4K@60Hz 4:4:4

PR-0602

The AMX PR-0602 provides the ability to connect up to six 4K UHD+ HDMI sources to up to two 4K UHD+ HDMI displays and freely switch between them. This unit comes with full support for 18Gbps resolutions up to, and including 4K@60Hz (4:4:4, 8-bit) as well as support for Deep Color, HDR (High Dynamic Range), HD audio and other features defined by the HDMI 2.0 specification. With a comprehensive EDID management feature that includes the ability to select between built in EDIDs, EDIDs copied from connected sink devices, as well as user provided EDIDs, this matrix can solve many interconnectivity problems.

Features

- HDMI Inputs and Outputs support up to 4K@60Hz 4:4:4 8bit
- Fully compliant with HDMI 2.0
- HDCP 2.2 compliant
- Supports 4K HDR
- Supports audio de-embedding for each HDMI output
- Supports IPv4 & IPv6 networks, support HTTPS, SSH
- Supports PCM 2-Channel, PCM Multi-Channel, Dolby Digital, Dolby Digital Plus, Dolby Atmos, Dolby True HD, DTS, DTS HD MA

Package Contents

- 1 x PR-0602
- 1 x 12V/3A DC Power Adapter
- 1 x US Pins
- 1 x UK Pins
- 1 x EU Pins
- 1 x AU Pins
- 3 x 3-Pin Terminal Blocks
- 2 x Mounting Ears
- 6 x Mounting Screws

Specifications

Technical	
Input	6 x HDMI IN
Input Resolution Supported	<p>VESA:</p> <p>640x480 @ 60, 72, 75, 85 Hz</p> <p>720 x 400 @ 70, 85 Hz</p> <p>800 x 600 @ 56, 60, 72, 75, 85 Hz</p> <p>848 x 480 @ 60 Hz</p> <p>1024 x 768 @ 60, 70, 75, 85 Hz</p> <p>1152 x 864 @ 75 Hz</p> <p>1280 x 768 @ 60 Hz, 75 Hz</p> <p>1280 x 800 @ 60 Hz (Reduce Blanking)</p> <p>1280 x 960 @ 60 Hz</p> <p>1280 x 1024 @ 60, 75, 85 Hz</p> <p>1360 x 768 @ 60 Hz</p> <p>1366 x 768 @ 60 Hz (Reduce Blanking)</p> <p>1400 x 1050 @ 60 Hz (Reduce Blanking), 75 Hz</p> <p>1440 x 900 @ 60 Hz (Reduce Blanking), 75, 85 Hz</p> <p>1600 x 900 @ 60 Hz (Reduce Blanking)</p> <p>1600 x 1200 @ 60 Hz</p> <p>1680 x 1050 @ 60 Hz (Reduce Blanking)</p> <p>1920 x 1200 @ 60 Hz (Reduce Blanking)</p> <p>1920 x 1200 @ 60 Hz</p> <p>1920 x 1440 @ 60 Hz</p> <p>2048 x 1080 @ 50, 60 Hz</p> <p>2560 x 1440 @ 60 Hz (Reduce Blanking)</p> <p>2560 x 1600 @ 60 Hz (Reduce Blanking)</p> <p>3840 x 2160 @ 60 Hz (Reduce Blanking)</p> <p>CEA Information Code (VIC) Formats:</p> <p>720 x 480i @ 59.94, 60 Hz</p> <p>720 x 576i @ 50 Hz</p> <p>720 x 480p @ 59.94, 60 Hz</p> <p>720 x 576p @ 50 Hz</p> <p>1280 x 720p @ 50, 59.94, 60 Hz</p> <p>1920 x 1080i @ 50, 59.94, 60 Hz</p> <p>1920 x 1080p @ 24, 25, 29.97, 30, 50, 59.94, 60 Hz</p> <p>2560 x 1080p @ 50, 60 Hz</p> <p>3840 x 2160p @ 24, 25, 29.97, 30, 50, 59.94, 60 Hz</p> <p>4096 x 2160p @ 24, 25, 29.97, 30, 50, 59.94, 60 Hz</p>

Input Audio Supported	PCM 2-Channel, PCM Multi-Channel, Dolby Digital, Dolby Digital Plus, Dolby Atmos, Dolby True HD, DTS, DTS HD MA
Output	2 x HDMI Out
Output Resolution Supported	Same as the Input
Analog Audio Output Level (Max)	+1.6 dB, unbalanced; ≥2 kohm load
Analog Audio Output Frequency Response	< -0.5 dB to +0.2 dB, 30 Hz to 20 kHz or < -0.8 dB to +0.2 dB, 20 Hz to 20 kHz
Analog Audio Output THD+N	<0.008%, 1 kHz, -10 dB to +2 dB
Analog Audio Output SNR	>100 dB, 20 Hz to 20 kHz Vin = +2 dB
Maximum Data Rate	18Gbps
Control Method	Front panel, IR, RS232 and Web GUI

General	
Operating Temperature	32F (0C) to 104F (40C)
Storage Temperature	-4°F (-20°C) to 140°F (60°C)
Humidity	5% to 90% (RH (non-condensing))
Power Supply	Voltage, DC: 12V/3A
Power Consumption (Max)	15.1W
EDS Protection	Human-body Model: ±10kV(Air-gap discharge)/±5kV(Contact discharge)
Device Dimension (W x H x D)	10.59 x 18.97 x 1.73
Product Weight	Approx. 6.3 lbs
Certification	FCC Part 15 Class B EN 55032 EN 55035 CB IEC/EN 60950 CB IEC/EN 62368-1 UL 62368-1 RoHS/REACH EMC (Australia) EMC (Canada) EMC (UKCA) Prop65

Transmission Distance

Note: Straight-through Ethernet cable of T568B is recommended.

General	Range	Supported Video
HDMI Output	15m/49ft	1080P@60Hz
	10m/33ft	4K@60Hz 4:2:0
	5m/16ft	4K@60Hz 4:4:4

PR-0404

The AMX PR-0404 provides the ability to connect up to four 4K UHD+ HDMI sources to up to four 4K UHD+ HDMI displays and freely switch between them. This unit comes with full support for 18Gbps resolutions up to, and including 4K@60Hz (4:4:4, 8-bit) as well as support for Deep Color, HDR (High Dynamic Range), HD audio and other features defined by the HDMI 2.0 specification. With a comprehensive EDID management feature that includes the ability to select between built in EDIDs, EDIDs copied from connected sink devices, as well as user provided EDIDs, this matrix can solve many interconnectivity problems.

Features

- HDMI Inputs and Outputs support up to 4K@60Hz 4:4:4 8bit
- Fully compliant with HDMI 2.0
- HDCP 2.2 compliant
- Supports 4K HDR
- Supports audio de-embedding for each HDMI output
- Supports IPv4 & IPv6 networks, support HTTPS, SSH
- Supports PCM 2-Channel, PCM Multi-Channel, Dolby Digital, Dolby Digital Plus, Dolby Atmos, Dolby True HD, DTS, DTS HD MA

Package Contents

- 1 x PR-0404
- 1 x 12V/3A DC Power Adapter
- 1 x US Pins
- 1 x UK Pins
- 1 x EU Pins
- 1 x AU Pins
- 5 x 3-Pin Terminal Blocks
- 2 x Mounting Ears
- 6 x Mounting Screws

Specifications

Technical	
Input	4 x HDMI IN
Input Resolution Supported	<p>VESA:</p> <p>640x480 @ 60, 72, 75, 85 Hz</p> <p>720 x 400 @ 70, 85 Hz</p> <p>800 x 600 @ 56, 60, 72, 75, 85 Hz</p> <p>848 x 480 @ 60 Hz</p> <p>1024 x 768 @ 60, 70, 75, 85 Hz</p> <p>1152 x 864 @ 75 Hz</p> <p>1280 x 768 @ 60 Hz, 75 Hz</p> <p>1280 x 800 @ 60 Hz (Reduce Blanking)</p> <p>1280 x 960 @ 60, 85 Hz</p> <p>1280 x 1024 @ 60, 75, 85 Hz</p> <p>1360 x 768 @ 60 Hz</p> <p>1366 x 768 @ 60 Hz (Reduce Blanking)</p> <p>1400 x 1050 @ 60 Hz (Reduce Blanking), 75 Hz</p> <p>1440 x 900 @ 60 Hz (Reduce Blanking), 75, 85 Hz</p> <p>1600 x 900 @ 60 Hz (Reduce Blanking)</p> <p>1600 x 1200 @ 60 Hz</p> <p>1680 x 1050 @ 60 Hz (Reduce Blanking)</p> <p>1920 x 1200 @ 60 Hz (Reduce Blanking)</p> <p>1920 x 1200 @ 60 Hz</p> <p>1920 x 1440 @ 60 Hz</p> <p>2048 x 1080 @ 50, 60 Hz</p> <p>2560 x 1440 @ 60 Hz (Reduce Blanking)</p> <p>2560 x 1600 @ 60 Hz (Reduce Blanking)</p> <p>3840 x 2160 @ 60 Hz (Reduce Blanking)</p> <p>CEA Information Code (VIC) Formats:</p> <p>720 x 480i @ 59.94, 60 Hz</p> <p>720 x 576i @ 50 Hz</p> <p>720 x 480p @ 59.94, 60 Hz</p> <p>720 x 576p @ 50 Hz</p> <p>1280 x 720p @ 50, 59.94, 60 Hz</p> <p>1920 x 1080i @ 50, 59.94, 60 Hz</p> <p>1920 x 1080p @ 24, 25, 29.97, 30, 50, 59.94, 60 Hz</p> <p>2560 x 1080p @ 50, 60 Hz</p> <p>3840 x 2160p @ 24, 25, 29.97, 30, 50, 59.94, 60 Hz</p> <p>4096 x 2160p @ 24, 25, 29.97, 30, 50, 59.94, 60 Hz</p>

Input Audio Supported	PCM 2-Channel, PCM Multi-Channel, Dolby Digital, Dolby Digital Plus, Dolby Atmos, Dolby True HD, DTS, DTS HD MA
Output	4 x HDMI Out
Output Resolution Supported	Same as the Input
Analog Audio Output Level(Max)	+1.6 dB, unbalanced; ≥2 kohm load
Analog Audio Output Frequency Response	< -0.5 dB to +0.2 dB, 30 Hz to 20 kHz or < -0.8 dB to +0.2 dB, 20 Hz to 20 kHz
Analog Audio Output THD+N	<0.008%, 1 kHz, -10 dB to +2 dB
Analog Audio Output SNR	>105 dB, 20 Hz to 20 kHz Vin = +2 dB
Maximum Data Rate	18Gbps
Control Method	Front panel, IR, RS232 and Web GUI

General	
Operating Temperature	32F (0C) to 104F (40C)
Storage Temperature	-4°F (-20°C) to 140°F (60°C)
Humidity	5% to 90% (RH (non-condensing))
Power Supply	Voltage, DC: 12V/3A
Power Consumption (Max)	34.8W
EDS Protection	Human-body Model: ±10kV(Air-gap discharge)/±5kV(Contact discharge)
Device Dimension (W x H x D)	10.59 x 18.97 x 1.73
Product Weight	Approx. 6.6 lbs
Certification	FCC Part 15 Class B EN 55032 EN 55035 CB IEC/EN 60950 CB IEC/EN 62368-1 UL 62368-1 RoHS/REACH EMC (Australia) EMC (Canada) EMC (UKCA) Prop65

Transmission Distance

Note: Straight-through Ethernet cable of T568B is recommended.

General	Range	Supported Video
HDMI Output	15m/49ft	1080P@60Hz
	10m/33ft	4K@60Hz 4:2:0
	5m/16ft	4K@60Hz 4:4:4

PR-0402

The AMX PR-0402 provides the ability to connect four 4K UHD+ HDMI sources to two 4K UHD+ HDMI displays, and freely switch between them. This unit comes with full support for 18Gbps resolutions, including 4K@60Hz (4:4:4, 8-bit) as well as support for Deep Color 36bits, HDR (High Dynamic Range), HBR audio and other features defined by the HDMI 2.0 specification. With a comprehensive EDID management feature that includes the ability to select between built in EDIDs, EDIDs copied from connected sink devices, as well as user provided EDIDs. This matrix can solve many interconnectivity problems.

Features

- HDMI Inputs and Outputs support up to 4K@60Hz 4:4:4 8bit
- Fully compliant with HDMI 2.0
- HDCP 2.2 compliant
- Supports 4K HDR
- Supports audio de-embedding for each HDMI output
- Supports IPv4 & IPv6 networks, support HTTPS, SSH
- Supports PCM 2-Channel, PCM Multi-Channel, Dolby Digital, Dolby Digital Plus, Dolby Atmos, Dolby True HD, DTS, DTS HD MA

Package Contents

- 1 x PR-0402
- 1 x 12V/3A DC Power Adapter
- 1 x US Pins
- 1 x UK Pins
- 1 x EU Pins
- 1 x AU Pins
- 3 x 3-Pin Terminal Blocks
- 4 x Rubber Feet

Specifications

Technical	
Input	4 x HDMI IN
Input Resolution Supported	<p>VESA:</p> <p>640 x 480 @ 60, 72, 75, 85 Hz</p> <p>720 x 400 @ 70, 85 Hz</p> <p>800 x 600 @ 56, 60, 72, 75, 85 Hz</p> <p>848 x 480 @ 60 Hz</p> <p>1024 x 768 @ 60, 70, 75, 85 Hz</p> <p>1152 x 864 @ 75 Hz</p> <p>1280 x 768 @ 60 Hz, 75 Hz</p> <p>1280 x 800 @ 60 Hz (Reduce Blanking)</p> <p>1280 x 960 @ 60, 85 Hz</p> <p>1280 x 1024 @ 60, 75, 85 Hz</p> <p>1360 x 768 @ 60 Hz</p> <p>1366 x 768 @ 60 Hz (Reduce Blanking)</p> <p>1400 x 1050 @ 60 Hz (Reduce Blanking), 75 Hz</p> <p>1440 x 900 @ 60 Hz (Reduce Blanking), 75, 85 Hz</p> <p>1600 x 900 @ 60 Hz (Reduce Blanking)</p> <p>1600 x 1200 @ 60 Hz</p> <p>1680 x 1050 @ 60 Hz (Reduce Blanking)</p> <p>1920 x 1200 @ 60 Hz (Reduce Blanking)</p> <p>1920 x 1200 @ 60 Hz</p> <p>1920 x 1440 @ 60 Hz</p> <p>2048 x 1080 @ 50, 60 Hz</p> <p>2560 x 1440 @ 60 Hz (Reduce Blanking)</p> <p>2560 x 1600 @ 60 Hz (Reduce Blanking)</p> <p>3840 x 2160 @ 60 Hz (Reduce Blanking)</p> <p>CEA Information Code (VIC) Formats:</p> <p>720 x 480i @ 59.94, 60 Hz</p> <p>720 x 576i @ 50 Hz</p> <p>720 x 480p @ 59.94, 60 Hz</p> <p>720 x 576p @ 50 Hz</p> <p>1280 x 720p @ 50, 59.94, 60 Hz</p> <p>1920 x 1080i @ 50, 59.94, 60 Hz</p> <p>1920 x 1080p @ 24, 25, 29.97, 30, 50, 59.94, 60 Hz</p> <p>2560 x 1080p @ 50, 60 Hz</p> <p>3840 x 2160p @ 24, 25, 29.97, 30, 50, 59.94, 60 Hz</p> <p>4096 x 2160p @ 24, 25, 29.97, 30, 50, 59.94, 60 Hz</p>

Input Audio Supported	PCM 2-Channel, PCM Multi-Channel, Dolby Digital, Dolby Digital Plus, Dolby Atmos, Dolby True HD, DTS, DTS HD MA
Output	2 x HDMI Out
Output Resolution Supported	Same as the Input
Analog Audio Output Level(Max)	+1.6 dB, unbalanced; ≥2 kohm load
Analog Audio Output Frequency Response	< -0.5 dB to +0.2 dB, 30 Hz to 20 kHz or < -0.8 dB to +0.2 dB, 20 Hz to 20 kHz
Analog Audio Output THD+N	<0.008%, 1 kHz, -10 dB to +2 dB
Analog Audio Output SNR	>99 dB, 20 Hz to 20 kHz Vin = +2 dB
Maximum Data Rate	18Gbps
Control Method	Front panel, IR, RS232 and Web GUI

General	
Operating Temperature	32F (0C) to 104F (40C)
Storage Temperature	-4°F (-20°C) to 140°F (60°C)
Humidity	5% to 90% (RH (non-condensing))
Power Supply	Voltage, DC: 12V/3A
Power Consumption (Max)	9.8W
EDS Protection	Human-body Model: ±10kV(Air-gap discharge)/±5kV(Contact discharge)
Device Dimension (W x H x D)	8.07 x 8.4 x 1.73
Product Weight	Approx. 2.9 lbs (1.3 kg)
Certification	FCC Part 15 Class B EN 55032 EN 55035 CB IEC/EN 60950 CB IEC/EN 62368-1 UL 62368-1 RoHS/REACH EMC (Australia) EMC (Canada) EMC (UKCA) Prop65

Transmission Distance

Note: Straight-through Ethernet cable of T568B is recommended.

General	Range	Supported Video
HDMI Output	15m/49ft	1080P@60Hz
	10m/33ft	4K@60Hz 4:2:0
	5m/16ft	4K@60Hz 4:4:4

Panel Description

PR-0808 Front Panel

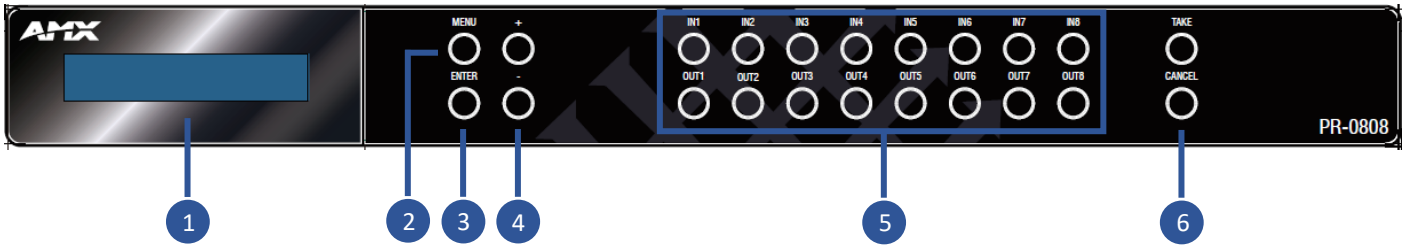

No.	Name	Description
1	Digital Indicator	Indicates menu items and input/output selections.
2	Menu Button	Press to enter the main menu, or to back out from menu items.
3	Enter button	Press Enter to go into the main menu and menu items.
4	Select buttons	Press "+" to scroll up and "-" to scroll down.
5	Switching Buttons	Selects the input and output channels.
6	Take & Cancel Buttons	Press Take & Cancel to initiate or cancel switching after selecting the desired inputs and outputs

Rear Panel

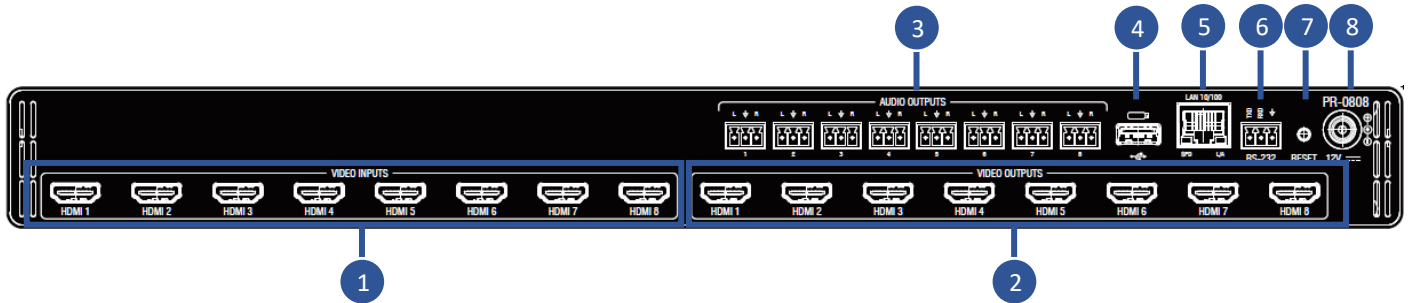

No.	Name	Description
1	VIDEO INPUTS	Connect to HDMI sources.
2	VIDEO INPUTS	Connect to HDMI display devices.
3	AUDIO OUTPUTS	Audio de-embedded outputs: 3 Pins Phoenix port: L/R analog audio output.
4	USB	Connects to USB port for firmware update.
5	LAN 10/100	Connects to network, used for Web GUI and Telnet control.
6	RS232	Connects to control system for RS232 control.
7	RESET	When the PR-0404, PR-0602 or PR-0808 is powered on, use a pointed stylus to hold down the RESET button for 3 seconds or more, then release the unit will reboot and restore to its factory defaults.
8	AC 12V/7.5A 90W	AC 12V/7.5A 90W power supply input.

Panel Description

PR-0602 Front Panel

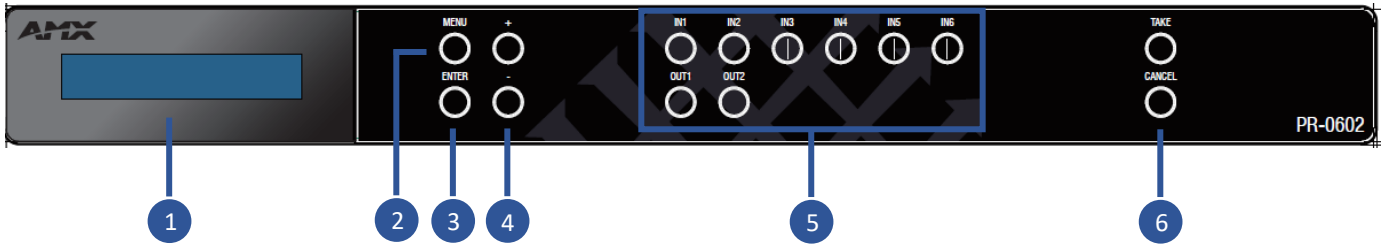

No.	Name	Description
1	Digital Indicator	Indicates menu items and input/output selections.
2	Menu Button	Press to enter the main menu, or to back out from menu items.
3	Enter button	Press Enter to go into the main menu and menu items.
4	Select buttons	Press “+” to scroll up and “-” to scroll down.
5	Switching Buttons	Selects the input and output channels.
6	Take & Cancel Buttons	Press Take & Cancel to initiate or cancel switching after selecting the desired inputs and outputs

Rear Panel

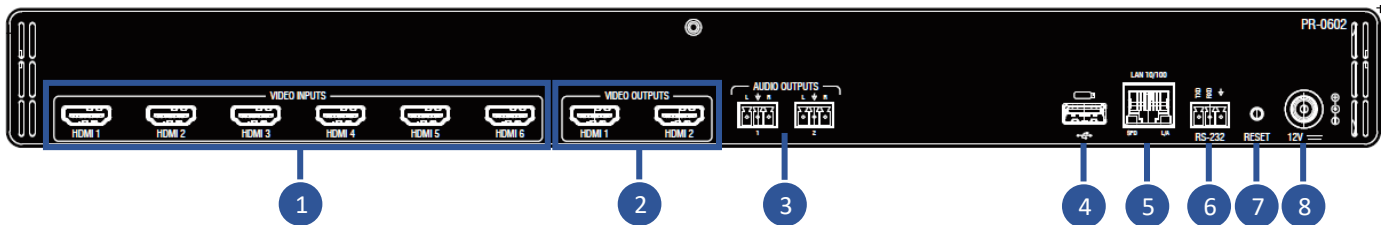

No.	Name	Description
1	VIDEO INPUTS	Connect to HDMI sources.
2	VIDEO OUTPUTS	Connect to HDMI display devices.
3	AUDIO OUTPUTS	Audio de-embedded outputs: 3 Pins Phoenix port: L/R analog audio output.
4	USB	Connects to USB port for firmware update.
5	LAN 10/100	Connects to network, used for Web GUI and Telnet control.
6	RS232	Connects to control system for RS232 control.
7	RESET	When the PR-0404, PR-0602 or PR-0808 is powered on, use a pointed stylus to hold down the RESET button for 3 seconds or more, then release the unit will reboot and restore to its factory defaults.
8	AC 12V/3A 36W	AC 12V/3A 36W power supply input.

Panel Description

PR-0404 Front Panel

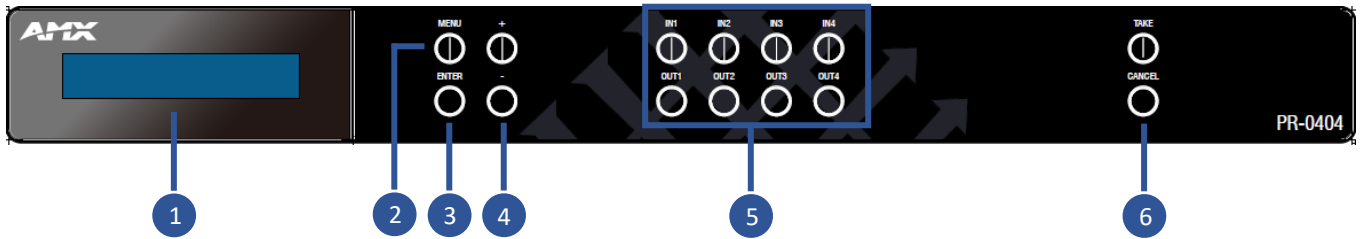

No.	Name	Description
1	Digital Indicator	Indicates menu items and input/output selections.
2	Menu Button	Press to enter the main menu, or to back out from menu items.
3	Enter button	Press Enter to go into the main menu and menu items.
4	Select buttons	Press “+” to scroll up and “-” to scroll down.
5	Switching Buttons	Selects the input and output channels.
6	Take & Cancel Buttons	Press Take & Cancel to initiate or cancel switching after selecting the desired inputs and outputs

Rear Panel

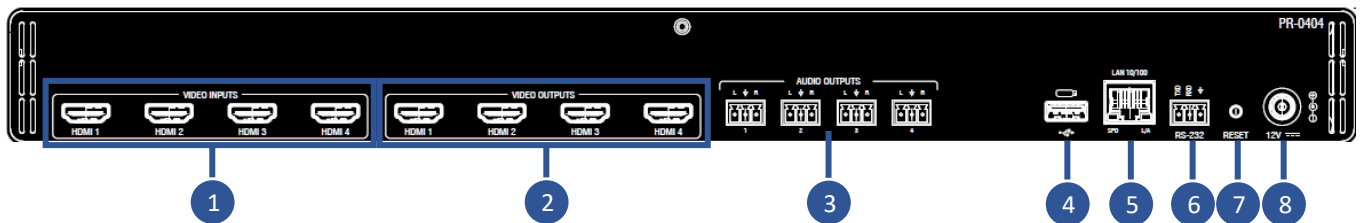

No.	Name	Description
1	VIDEO INPUTS	Connect to HDMI sources.
2	VIDEO OUTPUTS	Connect to HDMI display devices.
3	AUDIO OUTPUTS	Audio de-embedded outputs: 3 Pins Phoenix port: L/R analog audio output.
4	USB	Connects to USB port for firmware update.
5	LAN 10/100	Connects to network, used for Web GUI and Telnet control.
6	RS232	Connects to control system for RS232 control.
7	RESET	When the PR-0404, PR-0602 or PR-0808 is powered on, use a pointed stylus to hold down the RESET button for 3 seconds or more, then release the unit will reboot and restore to its factory defaults.
8	AC 12V/3A 36W	AC 12V/3A 36W power supply input.

Panel Description

PR-0402 Front Panel

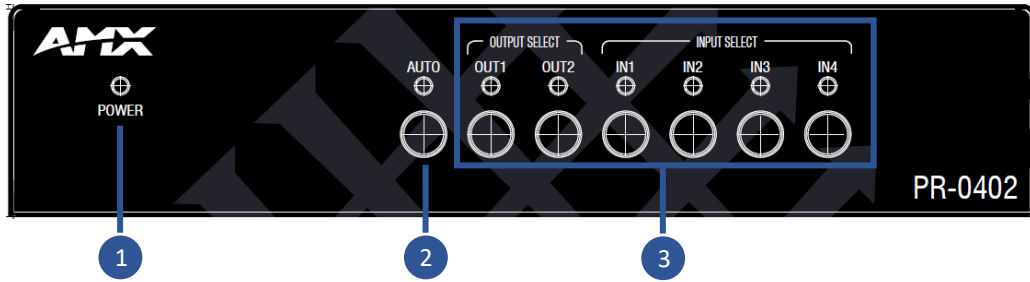

No.	Name	Description
1	Power Indicator	Indicates the status of the unit.
2	Auto Button	Press for auto switching.
3	Switching Buttons	Selects the input and output channels.

Rear Panel

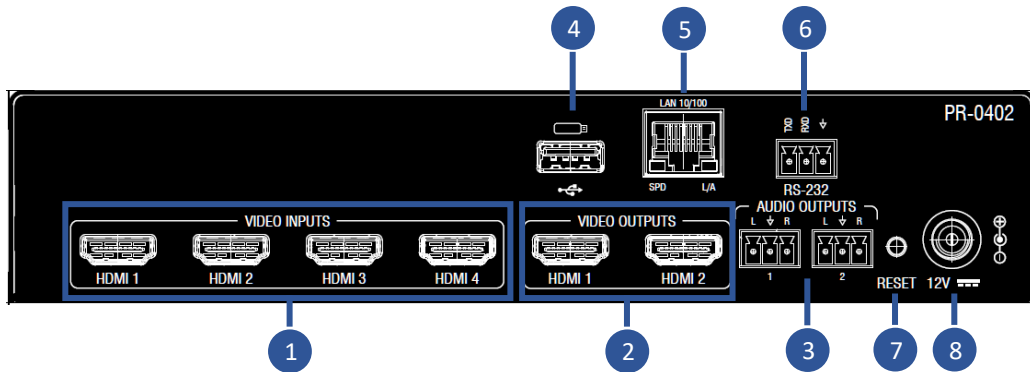

No.	Name	Description
1	VIDEO INPUTS	Connect to HDMI sources.
2	VIDEO OUTPUTS	Connect to HDMI display devices.
3	AUDIO OUTPUTS	Audio de-embedded outputs: 3 Pins Phoenix port: L/R analog audio output.
4	USB	Connects to USB port for firmware update.
5	LAN 10/100	Connects to network, used for Web GUI and Telnet control.
6	RS232	Connects to control system for RS232 control.
7	RESET	Use a pointed stylus to hold down the RESET button for 15 seconds or more, then the unit will start the reset default action and reboot.
8	AC 12V/3A 36W	AC 12V/3A 36W power supply input.

Installation and Wiring

Brackets Installation for PR-0808/0602/0404

Warning: Before installation, ensure the device is disconnected from the power source.

Steps to install the device in a suitable location:

1. First remove the screws mounted on the side.



2. Attach the installation bracket to the enclosure using the longer screws that were provided in the package separately.
3. The bracket is attached to the enclosure as shown.
4. Repeat steps 1-3 for the other side of the unit.

Wiring

PR-0808/PR-0602/PR-0404

Warning:

Before wiring, disconnect the power from all devices. Connecting or disconnecting cables while powered, may cause damage to circuitry or possible injury. Connect and disconnect the cables with care.

1. Using high quality HDMI cable, firmly connect 4K or HD source devices (such as: Blu-Ray, computer, games console, satellite/ cable, music streaming device, CCTV etc.) to the HDMI input ports 1-4 of the switcher.
2. Securely connect HDMI OUT 1-4 of the switcher to HDMI IN of 4K or HD display devices, make sure all sources and displays are compatible and correctly configured.
3. Securely connect AUDIO OUT 1-2 of the switcher to audio devices such as amplifier.
4. Insert the processor DC power cord. The front panel LEDs will lit on to indicate that the processor is ready for operation.
5. **Warning:** Always power off the processor before unplugging any HDMI cables following Last On, First Off protocol.
6. Switch between sources and displays using the processor front panel buttons, through serial RS232 or LAN.

PR-0808 Connection Diagram

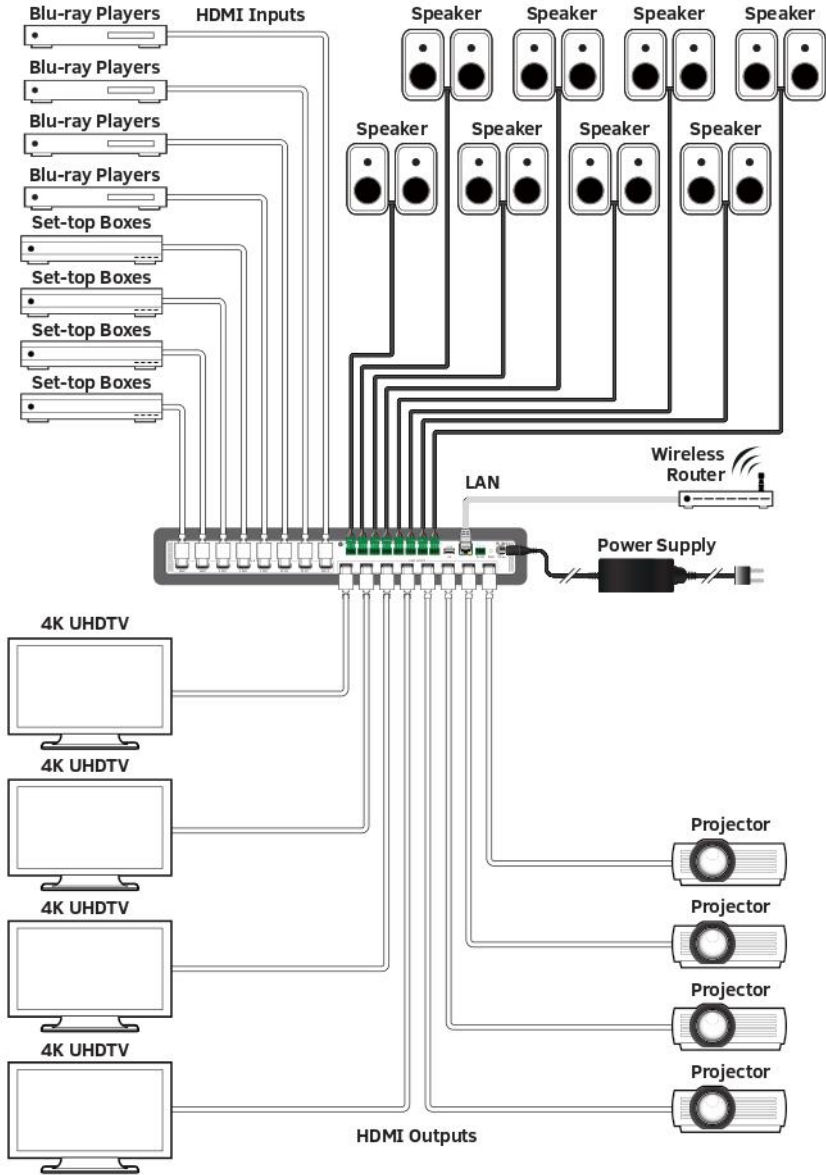

PR-0602 Connection Diagram

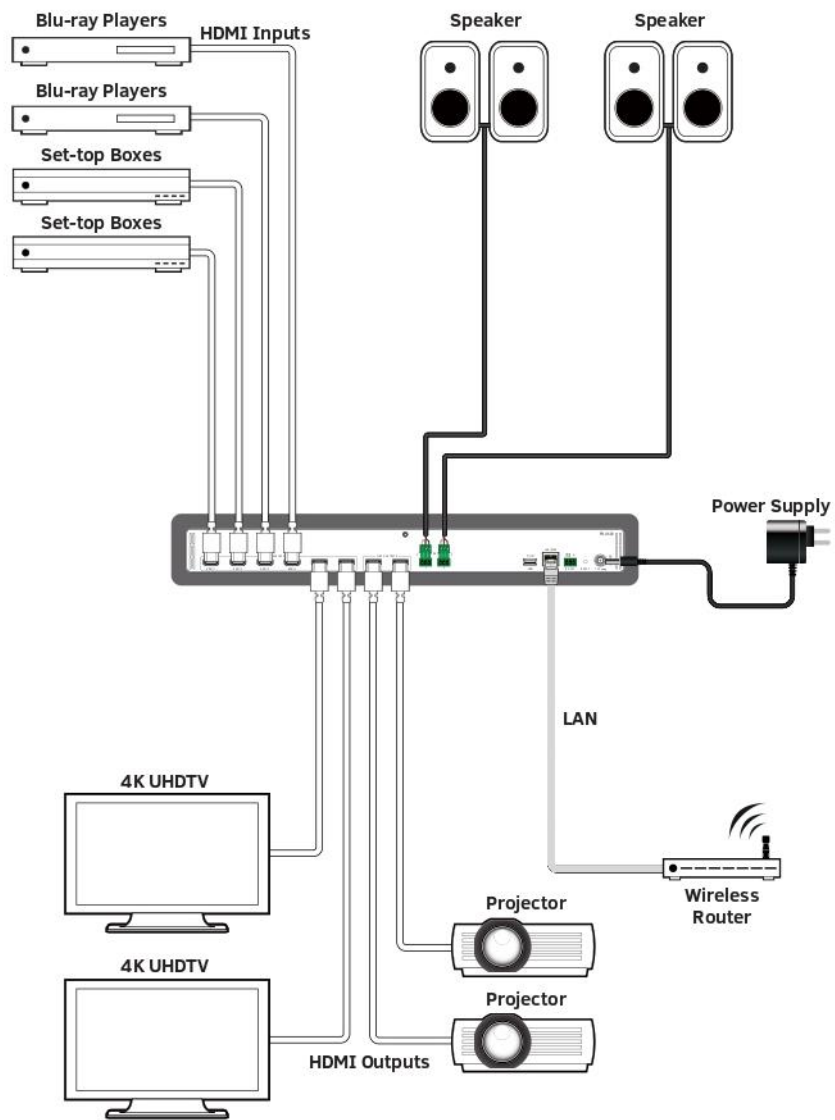

PR-0404 Connection Diagram

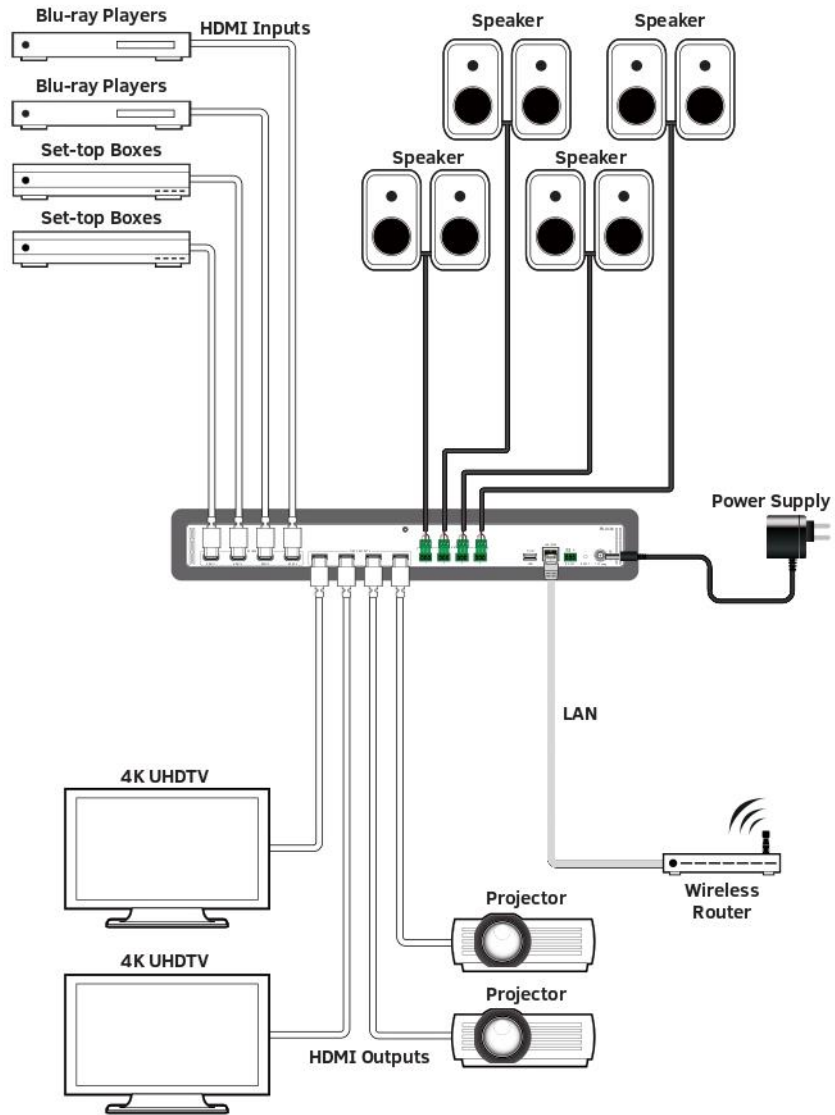

PR-0402

Warning:

Before wiring, disconnect the power from all devices. Connecting or disconnecting cables while powered, may cause damage to circuitry or possible injury. Connect and disconnect the cables with care.

1. Using high quality HDMI cable, firmly connect 4K or HD source devices (such as: Blu-Ray, computer, games console, satellite/ cable, music streaming device, CCTV etc.) to the HDMI input ports 1-4 of the switcher.
2. Securely connect HDMI OUT 1-4 of the switcher to HDMI IN of 4K or HD display devices, make sure all sources and displays are compatible and correctly configured.
3. Securely connect AUDIO OUT 1-2 of the switcher to audio devices such as amplifier.
4. Insert the processor DC power cord. The front panel LEDs will lit on to indicate that the processor is ready for operation.
5. Warning: Always power off the processor before unplugging any HDMI cables following Last On, First Off protocol.
6. Switch between sources and displays using the processor front panel buttons, through serial RS232 or LAN.

PR-0402 Connection Diagram

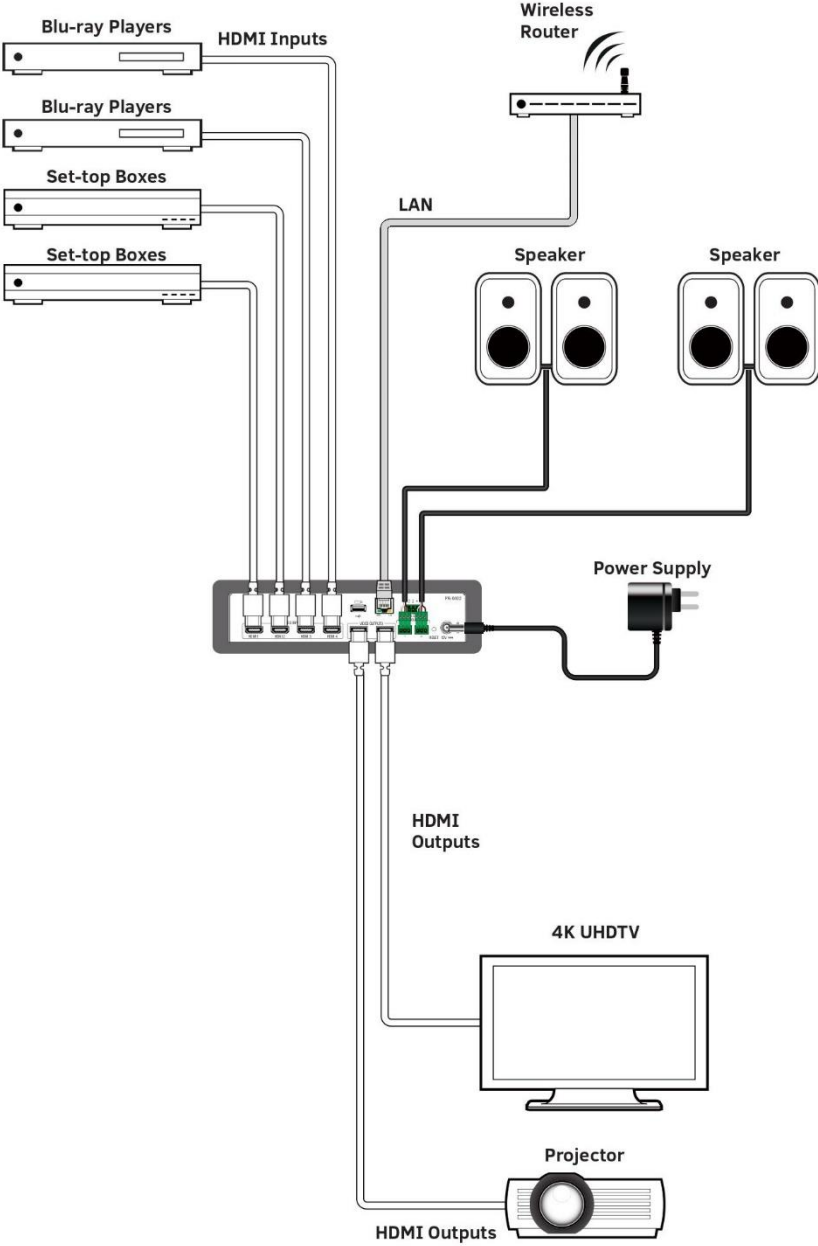

Front Panel Control

The PR-Series Matrixes are designed with ease of connection and control in mind. Basic switching of input sources to output displays can be achieved by pressing the front panel buttons with the front panel LCM (PR-0808/0602/0404) and LED (PR-0402) indicating the current input and output status of the matrix.

After powered up, the front panel LCM will show the matrix model name indicating the matrix is ready for operation.

PR-0808/PR-0602/PR-0404

Step1. Press IN1~IN8 to start video routing. The selected input port will flash once on the LCM, which indicates that the selection is taken.



Step2. Press OUT1~OUT8 to set the corresponding output ports. The selected output ports will flash once on the LCM, which indicates that the selection is taken. Press the selected output again to cancel each selection.



Step3. Press "TAKE" to finish routing, and the selected input and output ports will flash once on the LCM.

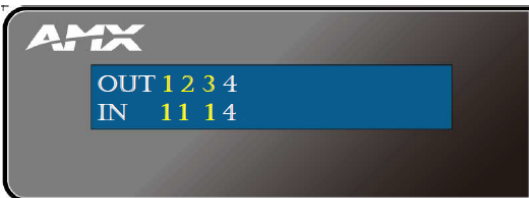

PR-0402

Step1. Press OUT1~OUT2 to start video routing.

Step2. Press IN1~IN4 to set the corresponding input ports. The corresponding LED lights up when selection is taken.

PR-0808/PR-0602/PR-0404 LCM Menu

LAYER 1	LAYER 2	LAYER 3	LAYER 4	LAYER 5
RECALL PRESET	PRESET 1 ~ 8			
VIDEO SETUP	EDID SETUP	IN 1 ~ 8	AUTO	
			4K60	3840x2160p,60Hz
				4096x2160p,60Hz
				1920x1080p,60Hz
			...	
	MIRROR OUT 1 ~ 8			
	HDCP SETUP-INPUT	IN 1 ~ 8	ENABLE/DISABLE	
	HDCP SETUP-OUTPUT	OUT 1 ~ 8	AUTO MODE	
			HDCP1.4 MODE	
			HDCP2.2 MODE	
BLANK COLOR	OUT 1 ~ 8	BLACK/BLUE		
CEC CONTORL	OUT 1 ~ 8	ON/OFF		
OSD	ENABLE/DISABLE			
AUDIO SETUP	OUT 1 ~ 8	ALL	ON/OFF	
		HDMI		
		ANALOG		
NETWORK STATUS	LINK:			
	MAC:			
	GATE:			
	MASK:			
	IP:			
	MODE:			
SYSTEM SETUP	FIRMWARE	[Info Display]		
	FACTORY RESET	Yes/No		
	FIRMWARE UPDATE	Yes/No		

RS232 Operation

RS232 Control

RS232 Phoenix Connector Pinout and RS232 Settings

The following figure shows the RS232 port Phoenix Connector pinout. Connect with the Phoenix Connectors provided and use the RS232 settings in the following table:

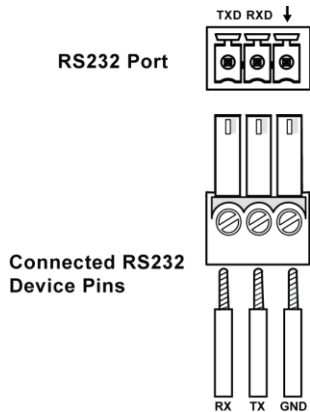

Parameters	Value
Baud Rate	9600
Data Bits	8 bits
Parity	None
Stop Bits	1 bit
Flow Control	None

The RS232 port is used to control the processor through RS232 serial communication using API commands. For security reasons, the RS232 API Command List does not enable System/Network/security commands. It has a subset of the standard API available via Telnet shown in **Appendix: API Command List Instructions**. The RS232 API Commands are shown below. See the Appendix for the full list and instructions for these commands.

RS232 API Command List

```

---Configuration Commands - Input---
get vidin portname      Get the name of the specified input
set vidin portname     Set the name of the specified input
get vidin htcp         Get the HDCP mode for the specified input
set vidin htcp         Set the HDCP mode for the specified input
get vidin res         Get input video resolution for the specified input
get vidin status      Get input video status for the specified input
get vidin edidmode    Get edid mode for the specified input
set vidin edidmode    Set edid mode for the specified input
get vidin prefedid    Get preferred resolution in the current edid used for the
                    specified input, no matter it is under which EDID mode
set vidin prefedid    Set preferred edid for the specified input
get vidin ediddata    Get current edid data used for the specified input port
set vidin ediddata    Set edid data for the specified input channel as custom edid

---Configuration Commands - Output---
get vidout portname    Get the name of the specified output port
set vidout portname   Set the name of the specified output port
get vidout htcp       Get HDCP mode for the specified output
set vidout htcp       Set HDCP mode for the specified output
get vidout res        Get video resolution for the specified output
get vidout osd        Get osd enable state for video output
set vidout osd        Set osd enable state for video output
get vidout osd color  Get osd color setting for video output
set vidout osd color  Set osd color setting for video output
get vidout osd pos    Get osd position for video output
set vidout osd pos    Set osd position for video output
get vidout cec power  Get current power status from the sink via CEC
set vidout cec power  Set power status on/off for the sink device via CEC
set vidout cec standby Set power standby for the sink device via CEC on specified port
set vidout cec makeactive Make active for the sink device via CEC on specified port
get vidout cec disp auto   get cec display auto on/off state for specified output
set vidout cec disp auto   set cec display auto on/off state for specified output
get vidout cec sleep timeout get cec display auto on/off delay time for specified output
set vidout cec sleep timeout set cec display auto on/off delay time for specified output
get vidout mute        get video mute state for specified output
set vidout mute        set video mute for specified output
get vidout blank      get video blank setting for specified output
set vidout blank      set vidout blank setting for specified output
get vidout sleep      get vidout tmds sleep on/off setting for specified output
set vidout sleep      set vidout tmds sleep on/off setting for specified output
get vidout sleep delay  get vidout tmds sleep on/off delay time for specified output
set vidout sleep delay  set vidout tmds sleep on/off delay time for specified output

```

RS232 API Command List (continued)

get audout mute	get audio mute state for the specified output
set audout mute	set audio mute for the specified output
get audout format	get audio output format for the specified output
set audout format	set audio output format for the specified output
get vidout ediddata	get edid data for the sink on specified output
---Switching Commands---	
load preset	load the specified preset mode for switcher setting
save preset	save current switcher setting as the specified preset mode
get preset name	get preset name for the specified preset mode
set preset name	set preset name for the specified preset mode
get switch VI	get which video outputs is switched to specified input
get switch VO	get which video input is switched to specified output
set switch VI	set switch video for input port to the output port
get switch CI	get which outputs is switched to specified input
get switch CO	get which input is switched to specified output
set switch CI	set switch both the audio and video input to the output port.

WebGUI Control

Identify the IP address of the PR-0808/PR-0602/PR-0404

Press the MENU button to enter the main menu, and then use the UP and DOWN buttons to search for the “NETWORK STATUS” page. Press the ENTER button to enter the selected page. The current IP address of the device will be presented on the device’s front display.

Identify the IP address of the PR-0402

Press the RESET ID button twice to show the OSD INFO, and then the current IP address will be presented on the displays connected to the HDMI OUT ports.

Access the Web Interface

To access the WebGUI:

1. Connect your PC and the LAN port of the PR-Series units to the same local area network.
2. Type the IP address of the unit into the address bar of the browser. The following page will pop up.
Note: When using the Web Interface, Chrome, Safari, Firefox, Opera and IE10+ browsers are supported. Make sure the web browser is the latest version.

PR-0404 HDMI Matrix Switcher

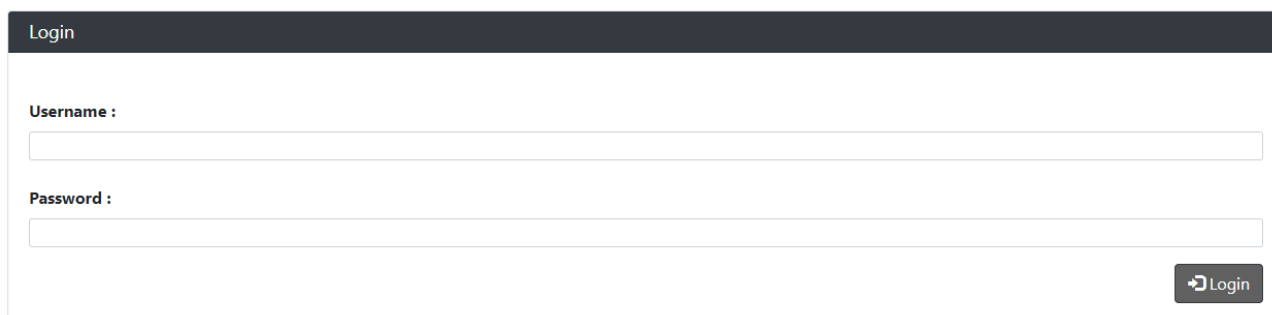

3. Enter the default Username and Password (“**administrator**” and “**password**”). Then click “Login”.
4. After logging in, the main screen appears.

Note: If upgrading from an older version that only required “admin” to login, a reset factory may be required to make the new Username and Password take effect.

Web Interface Introduction

Network

In the Network Column, users can set up the IPv4, IPv6 and 802.1x environments with the following IP mode settings:

- **DHCP:** When enabled, the IP address of the PR-Series units will be assigned automatically by the connected DHCP server.
- **Static:** When the PR-Series units fail to obtain or detect an IP address from the network to which it is connected, select “Static” to set up the IP address manually.

- **Accept:** Click to initiate the network setting.

IPv4 Setup IPv6 Setup 802.1x

IPv4 Network Settings for the System.
Press the Accept button to save changes. Press the Reset button to revert values from the System.

IPv4 Address	DNS Address
<p>IP Hostname : PR-0404-</p> <p><input type="button" value="DHCP"/> <input type="button" value="Static IP Address"/></p> <p>IP Address : 192.168.4.69</p> <p>Subnet Mask : 255.255.255.0</p> <p>Gateway : 192.168.4.254</p>	<p>Domain : amx.com</p> <p>DNS IP 1 : 8.8.8.8</p> <p>DNS IP 2 : 8.8.4.4</p> <p>DNS IP 3 : 9.9.9.9</p>

IPv4 Setup IPv6 Setup 802.1x

IPv6 Network Settings for the System.

IPv6 Address

IPv6 Address :
0000:0000:0000:0000:0000:0000:0000:0000

Subnet Prefix Length :
128

Default Gateway :
0000:0000:0000:0000:0000:0000:0000:0000

IPv4 Setup IPv6 Setup 802.1x

802.1x

IEEE 802.1x Authentication

Status : Enabled

Authentication Method :
EAP-MSCHAP V2 Password

Domain :
amx.com

Username :
admin

Password :
Password

Security

In the Security Column, modification can be made for the Login Password.

Username	Action
administrator	<button>Change Password</button>

- **Web User Management:** The Login Password default is **password**.
 1. Click the “**Change Password**” button and the following window pops up for new password verification.
 2. Click the “**Accept**” button to save the changes.

Note: Passwords must be 4 to 16 characters in length (alphanumeric only).

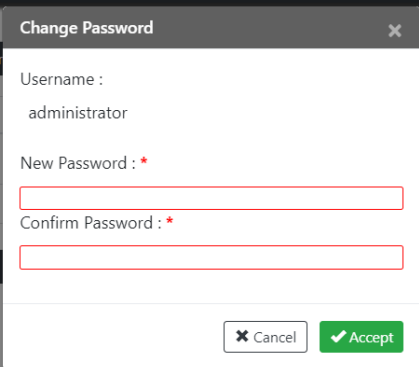

A dialog box titled "Change Password" with a close button (X) in the top right corner. It contains the following fields and controls:

- Username : administrator
- New Password : * (with an empty text input field)
- Confirm Password : * (with an empty text input field)
- Buttons: Cancel (with an X icon) and Accept (with a checkmark icon)

- **SSH/Telnet Account:** SSH/Telnet Account is used to configure the user name and password of the account. For SSH Account, the default user name is **admin**, the default password is **admin**. For Telnet Account, the default user name and password are null.

Note: Reboot the device for the SSH changes to take effect.

SSH Account	Telnet Account
Access : <input type="checkbox"/> ON <input type="checkbox"/> OFF	Access : <input type="checkbox"/> ON <input type="checkbox"/> OFF
Username : <input type="text"/>	Username : <input type="text"/>
Password : <input type="text"/>	Password : <input type="text"/>
<input type="button" value="Accept"/>	<input type="button" value="Accept"/>

- **Certification Management:** In the Certification Management column,
 - **Private Key:** Click on the “**Browse**” button and locate the Private Key file on your local PC then click “**Open**” to install the key in the unit.
 - **Certificate:** Click on the “**Browse**” button and locate the Certificate file on your local PC then click “**Open**” to install the certificate in the unit.

- **Password:** Set the password used to encrypt the content stream. After entering the password press the "Accept" button to store the settings

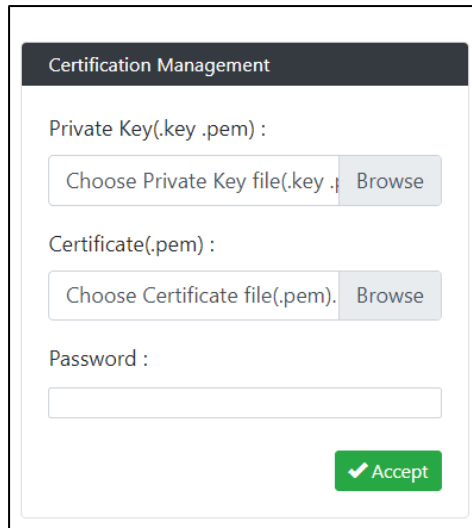

The screenshot shows a dialog box titled "Certification Management". It contains three input fields: "Private Key(.key .pem) :" with a "Browse" button, "Certificate(.pem) :" with a "Browse" button, and "Password :". At the bottom right, there is a green "Accept" button with a checkmark icon.

- **LDAP:** Select whether you want to Enable or Disable the LDAP function. Entering the corresponding Information and click "Accept/Test". After these steps, you should be able to log in via your LDAP accounts and password.

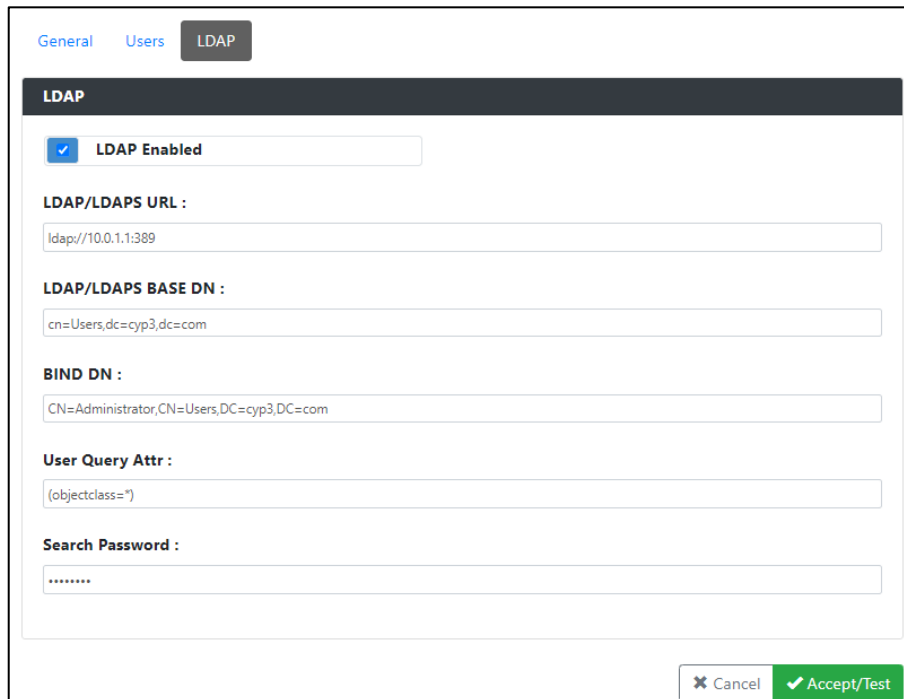

The screenshot shows a dialog box with tabs for "General", "Users", and "LDAP". The "LDAP" tab is selected. The dialog is titled "LDAP" and contains several fields: "LDAP Enabled" (checked), "LDAP/LDAPS URL :" (ldap://10.0.1.1:389), "LDAP/LDAPS BASE DN :" (cn=Users,dc=cyp3,dc=com), "BIND DN :" (CN=Administrator,CN=Users,DC=cyp3,DC=com), "User Query Attr :" ((objectclass=)), and "Search Password :". At the bottom right, there are "Cancel" and "Accept/Test" buttons.

Switcher

In the Switcher Column, 3 submenus are used to perform the settings of routing.

- **Switching**

The Switch manages the connection configurations of displays and sources.

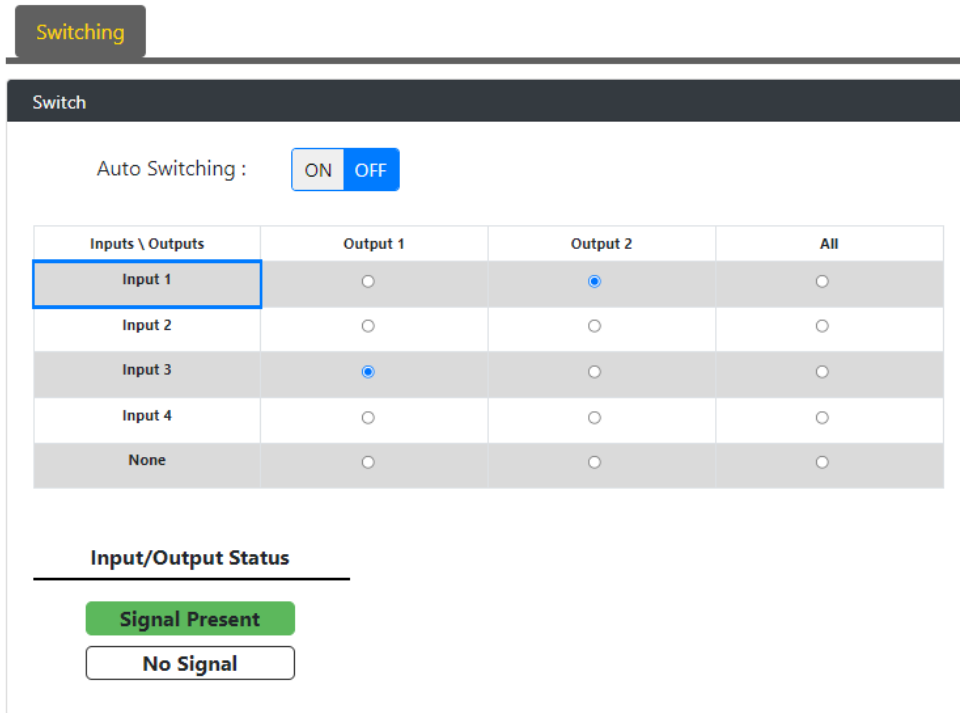

The input/output switch allows selection of output port (display) and input port (source) for specific combinations of displays and sources within the matrix. Click the white button, it will become blue, which represents that the input and output are routed.

All: Route all outputs to one input.

None: Route output to none (turn off output). Auto Switching is for PR-0402 only.

- **On-Screen Display**

All functions of the unit can be controlled by using the OSD (On-Screen Display) which is activated by pressing the MENU button on the front of the unit. Enable and disable OSD information and further define its color and position.

- **OSD Color:** Set OSD color as black or blue.
- **OSD Position:** Set OSD position as top left, top right, bottom left, bottom right or center.

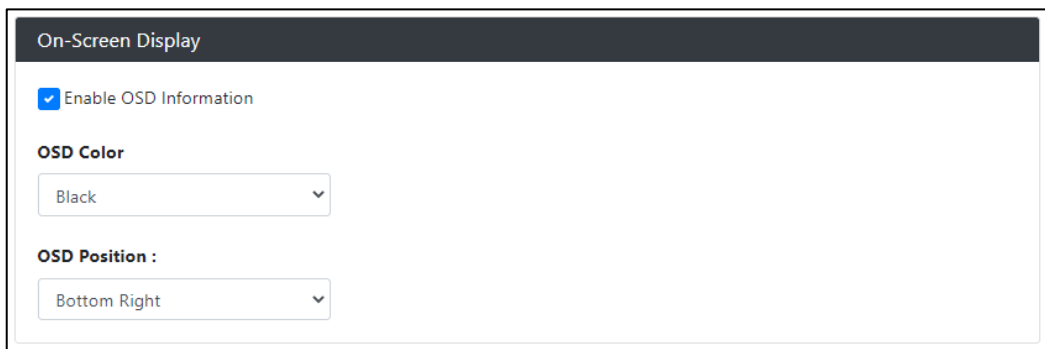

- **Preset**

Only matrix inputs/outputs selection states can be saved as presets for loading to the matrix.

Save: Save the selection states in the Switch submenu.

Load: Load the preset which has been saved.

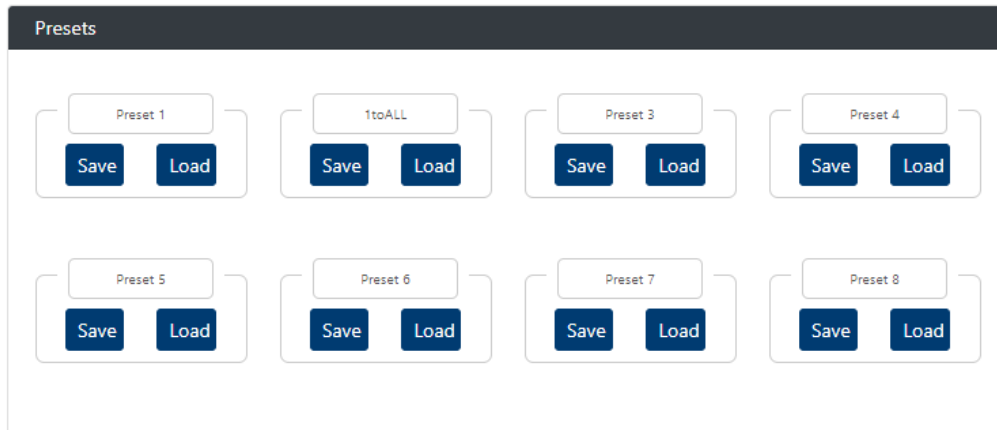

- **Configuration**

Users can set the Input / Output names by clicking on an Input or Output button in the Switching tab, entering the desired name in the Input/Output Name box on the Configuration panel. Then click **“Accept”** to save changes.

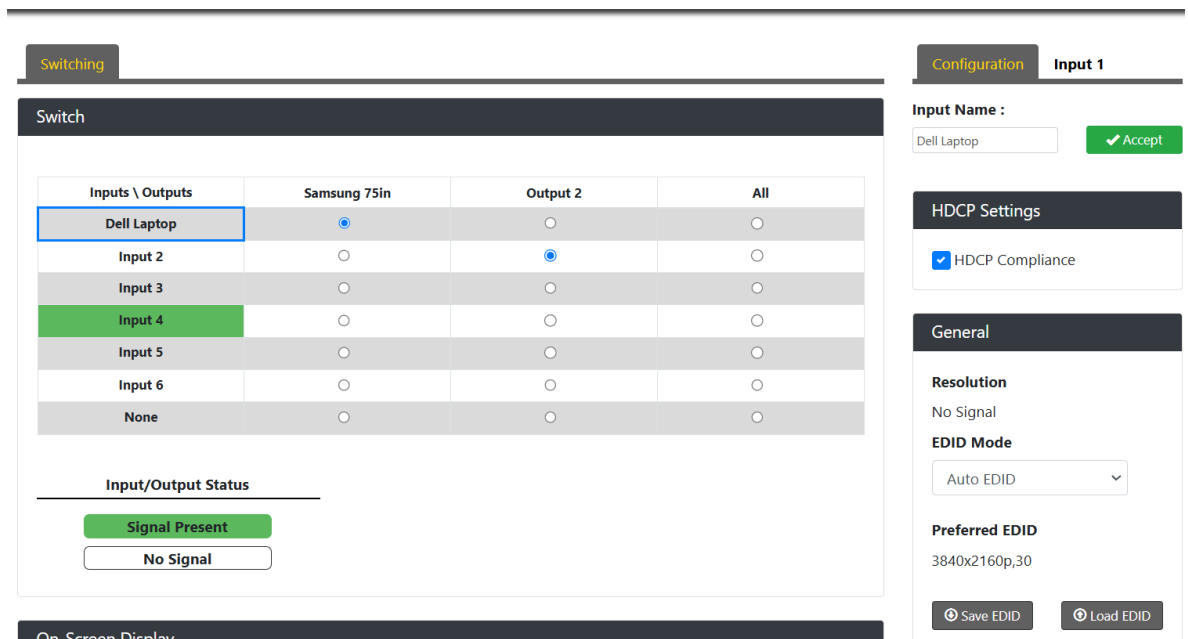

- **Input Configuration**

- **HDCP Settings**

HDCP Compliance support of HDMI Input 1-4 ports can be set.

- **General**

Set EDID Mode as “Auto EDID” or select one of the other fixed, Custom or Mirrored EDID option from the drop-down menu. To use a Custom EDID, first use the “Load EDID” button to load a customer edid, then select Custom from the EDID options. “Save EDID” can be used to save the currently selected EDID.

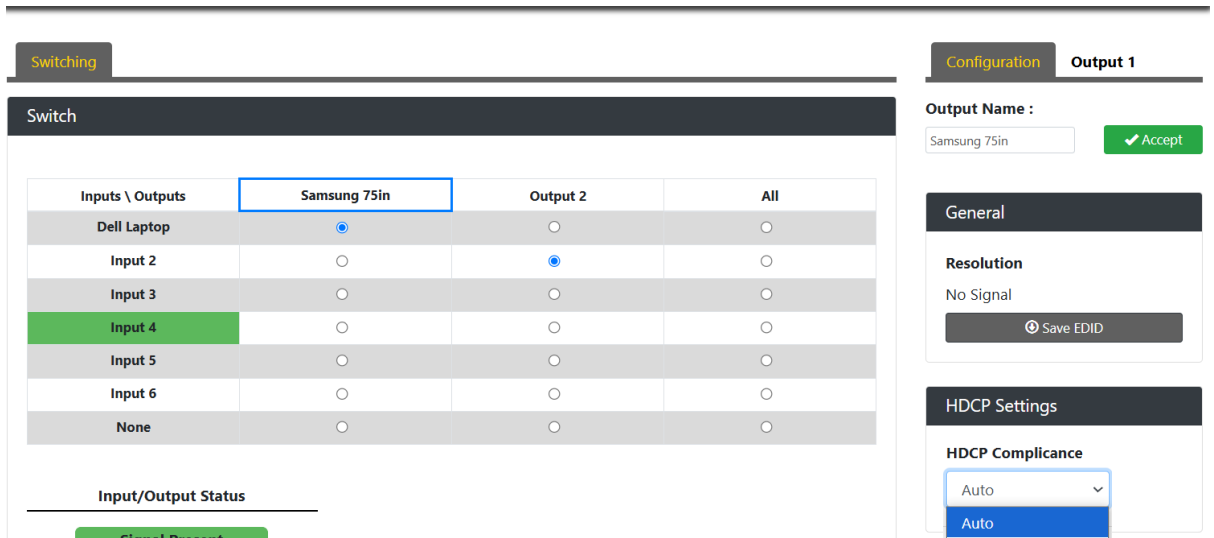

- **Output Configuration**

- **General**

Resolution will show the current resolution being sent to the display. The PR-Series switchers do not have a built in scaler so they will pass the input signal to the connected outputs unaltered.

“Save EDID” will save the EDID of the connected display.

- **Display Settings**

Check the box to Mute the video to that output

- **Blank Color**

Set the blanking color when no valid signal is routed. Options are Black, Red, Green or Blue.

- **Display Sleep**

Check the box to Allow the Display to Sleep when there is no valid input. Set the Delay Time in seconds before the display sleeps with the number field.

- **CEC Settings**

Manually power On/Off the display or use the Auto Power On/Off option to allow the display to be triggered via standard CEC commands. Set the Delay Time in minutes for when the CEC On/Off should be triggered.

- **Audio**

Check the box to Mute the audio. Use the Audio Format drop down to select the audio format(s) to be muted.

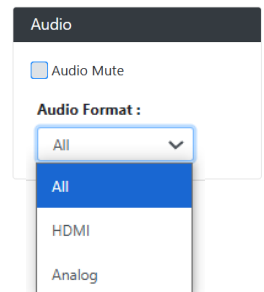
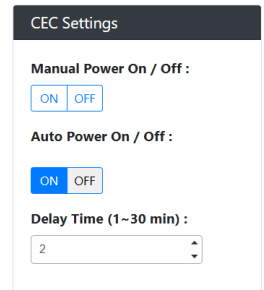
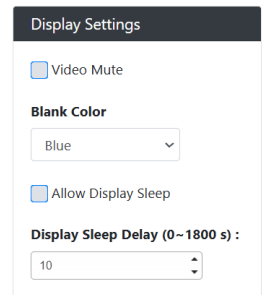

System

In the System Column, users can set up following settings:

- **Firmware Version:** In the Firmware Version column, the firmware version can be checked.

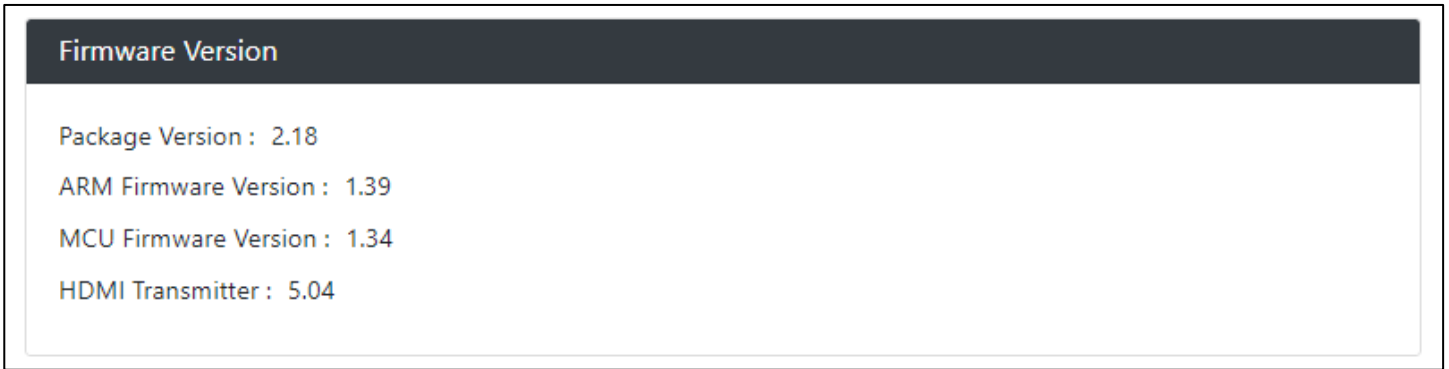

- **RS-232 Settings:** In the RS-232 Settings column, users can choose to turn "ON" or "OFF" the RS-232 stream and set the following configuration:
 - **Baud Rate:** Set the baud rate. The available range is from 2400 to 115200 baud.
 - **Parity Bits:** Set the connection parity bit. The available options are: none, odd, and even.
 - **Data Bits:** Set the number of data bits. The available range is from 7 to 8.
 - **Stop Bits:** Set the number of stop bits. The available range is from 1 to 2.

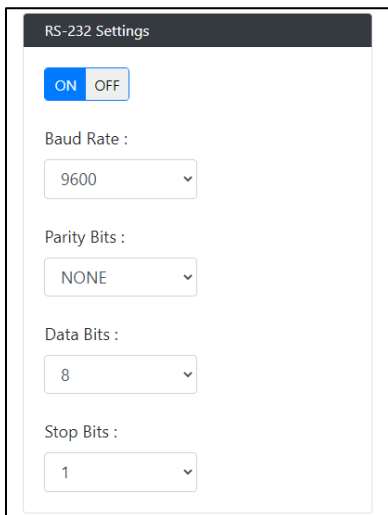

- **Panel Lock:** In the Panel Lock column, the front panel lock can be set as "OFF", "Menu" or "ALL".

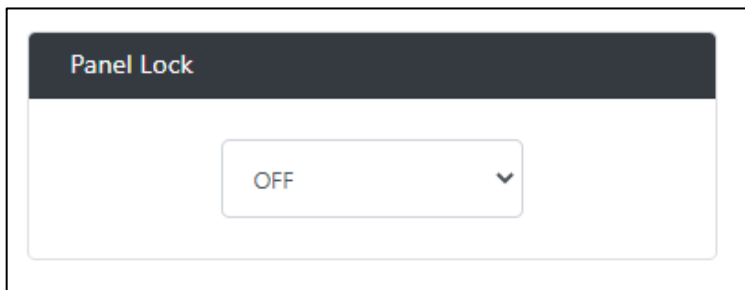

- **System:** In the System column, the unit can be set to "Reboot" and "Factory Default".

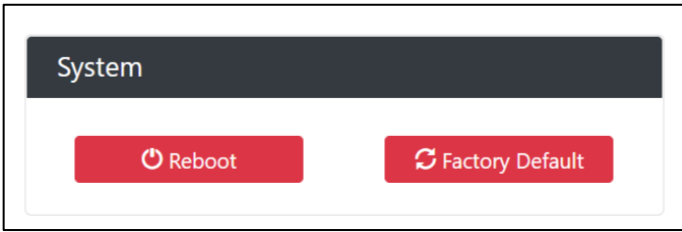

- **Device Configuration:** In the Device Configuration column, the current configuration can be saved and saved settings can be loaded.
 - **Save Config:** Save current settings as a setting file to be saved to a PC.
 - **Load Config:** Click to load a setting file from PC to Matrix.

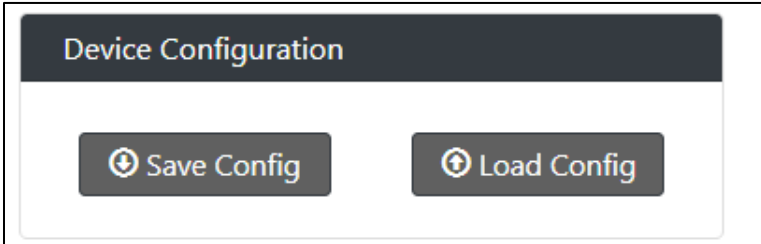

- **Device Log:** In the Device Log column, log files can be saved to a PC.

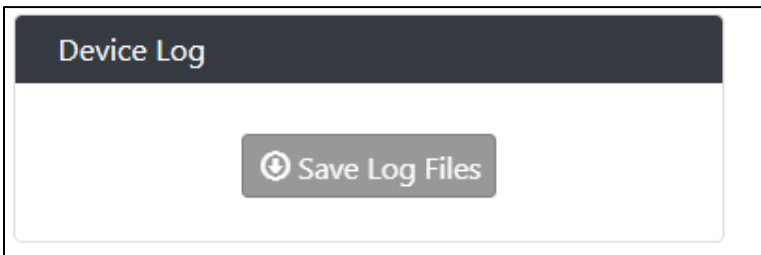

- **Standby:** Set ON/OFF of the Standby Mode.

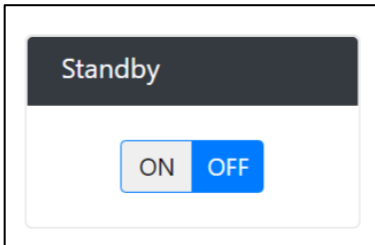

- **Firmware Update:** In the Firmware Update column, the firmware can be upgraded.

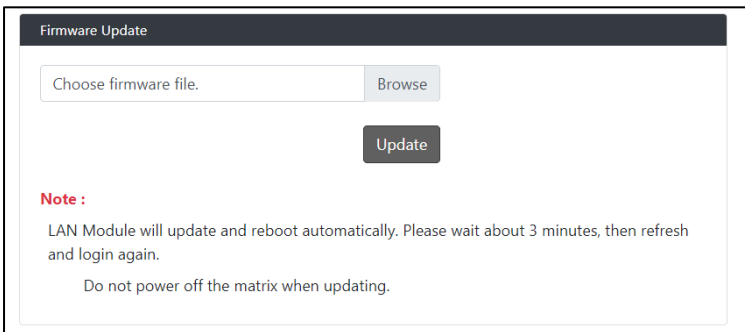

Firmware Upgrade

The PR-Series uses KIT files for firmware upgrade.

Before Starting

1. Download the latest firmware (KIT) file to your PC. (Place KIT files on a local drive for the fastest throughput.)
2. Verify the following:
 - Verify that an Ethernet/RJ-45 cable is connected from the PR-Series to the same network as the control system.
 - Verify that the PR-Series unit is powered ON.
3. Launch WebGUI page before you upgrade firmware to know the status of upgrading. More information, please refer to **UPGRADE STATUS** part in **WebGUI Control** section.

Firmware Upgrade through WebGUI

The system will be non-operational during the upgrade procedure below.

1. In the **Switcher Configuration** menu, enter the "System" page and then click "Browse" in the **Firmware Update** Column to open the file selection window.
2. Select the appropriate KIT file from the target directory.
3. Click "Update" to start firmware upgrading. The "Power" LED turns RED and keeps flashing.
4. Once the "Power" LED turns GREEN and stop flashing, the unit finishes upgrading and auto reboots to active.

Firmware Upgrade through USB

The system will be non-operational during the upgrade procedure below.

1. Copy firmware file to folder in USB original disk
2. Insert USB Disk to USB Type A program port
3. Press "Reset" button on the rear panel 5 times in a row, and the unit starts upgrading when the "Power" LED turns RED and keeps flashing.
4. Once the "Power" LED turns GREEN and stop flashing, the unit finishes upgrading and auto reboots to active.

Troubleshooting

1. Power: Ensure all devices are powered on (sources, transmitter, receiver and display).
2. Indicator: Please make sure all LED indicators of the receiver is normal according to the user manual.
3. Devices: Ensure picture can be shown normally when directly connecting a source to a display device.
4. Cable: Plug in and out HDMI cable or try another HDMI cable.
5. Ensure the cable length being used is within available transmission range according to the Specification Section.
6. Compatibility: Test other source and display devices to determine correct compatibility.

Appendix: API Command List Instructions

System Commands (Telnet only)

No.	Command	Description	Variables	Example
1.	? Or help	Display the commands listed in the table		<p>Command sent: >?</p> <p>Response: ----- Help ----- --System Commands-- ? Or help This list ping ping to specified IP address fwversion Request the firmware version of the device</p>
2.	?<command>	Show details about the specified command function		<p>Command sent: >?set vidin hdcp</p> <p>Response: ----- Description: Set the HDCP mode for the specified input Example: Command send: set vidin hdcp:1,off response: set HDCP compliance off for input port 1 -----</p>
3.	ping	Ping to specified IP address		<p>Command sent: >ping 192.168.1.2</p> <p>Response: ping 192.168.1.2 is alive.</p>
4.	fwversion	Request the firmware version of the device <u>NOTE: Command response shall list all upgradable components firmware version</u>		<p>Command sent: >fwversion</p> <p>Response: Package: 1.38 ARM: 1.15 MCU: 1.11</p>
5.	fwupdatestatus	Report device's firmware update status with node		<p>Command sent: >fwupdatestatus</p> <p>Response:</p>

		number		<p>device firmware update status -100%</p> <p>Firmware update status: copying file from web finish</p> <p>device firmware update status -99%</p> <p>Firmware update status: Updating MCU</p> <p>device firmware update status -97%</p> <p>device firmware update status -94%</p> <p>device firmware update status -90%</p> <p>device firmware update status -70%</p> <p>Firmware update status: Updating APP</p> <p>device firmware update status -60%</p> <p>device firmware update status -19%</p> <p>device firmware update status -0%</p> <p>Firmware update status: Update complete</p> <p>Firmware update status: Please wait system reboot, do not power off device</p>
6.	standby <on/off>	Set device to standby on or off		<p>Command sent:</p> <p>>standby on</p> <p>Response:</p> <p>Notice: device cannot receive signal when standby on, it need send standby off command to enter normal working mode</p> <p>Would you like to set device standby on? Y/N ->y</p> <p>The device is standby on</p> <p>>set device standby on</p>
7.	reboot	Reboot the device		<p>Command sent:</p> <p>>reboot</p> <p>Response:</p> <p>Rebooting.....</p>
8.	reset factory	Force the unit to a factory state (except for IP Settings)		<p>Command sent:</p> <p>>reset factory</p> <p>Response:</p> <p>Resetting device to factory default parameters. Device will automatically reboot shortly. Do NOT power off.</p>
9.	factoryfwimage	Restore device to factory firmware image		<p>Command sent:</p> <p>>factoryfwimage</p> <p>Response:</p> <p>Are you sure you wish to reset factory parameters, and load the factory firmware image of Version <factory image fw version> (Y/N) ->y</p>

				--Notice:it will take some time, please keep device power on-- Start restore to factory firmware image.....
10.	get sn	Get device serial number		Command sent: >get sn Response: Serial Number:123456789
11.	set serial <on/off>	Set serial port on or off		Command sent: >set serial on Response: Serial port is on
12.	get baud	Get serial port current communicate parameters		Command sent: >get baud Response: --Current serial setting-- baud rate:115200 data bit:8 parity:even stop bit:1
13.	set baud	Set serial port communicate parameters		Command sent: >set baud Response: --Serial port setting-- Enter baud rate(115200,57600,38400,19200,9600,4800,2400) ->115200 Enter data bit(8 or 7) ->8 Enter parity (E for Even, O for Odd, N for none) ->O Enter stop bit (1 or 2) ->1 Would you like to save the new settings? Y/N ->Y New settings were saved >--Current serial port baud rate: 115200 >--Current serial port data bit: 8 >--Current serial port parity: odd >--Current serial port stop bit: 1
14.	get key lock	Get front panel key lock state		Command sent: >get key lock Response: --Current key lock level state:all
15.	set key lock	Set front panel key lock level, all for lock		Command sent: >set key lock Response:

		all front panel key button, menu for only lock menu key button		--Front panel key lock level Setting-- Enter key lock level (All for all key button, Menu for only menu button, Off for no key button) ->menu Key lock is set to menu >--Current key lock level state:menu
16.	exit	Close telnet/ssh window session <u>NOTE: The command sent by Serial port is not supported</u>		Command sent: >exit

Network Commands (Telnet only)

No.	Command	Description	Variables	Example
1.	get friendly	Get device's hostname		Command sent: >get friendly Response: --Current device friendly name:PR-0602-3456789
2.	set friendly	Set device's hostname		Command sent: >set friendly Response: Please input friendly name: Old friendlyname: PR-0602-3456789 New friendlyname: PR-0602 Would you like to save this setting(Y/N)y Setting is ok , you should reboot that make it effective >--Current device friendly name:PR-0602
3.	get ip	Show the IP configuration of this device		Command sent: >get ip Response: IP Settings ----- HostName: PR-0602 Type: dhcp IP Address: 192.168.1.2 Subnet Mask: 255.255.0.0 Gateway IP: 192.168.1.1 MAC Address: f8:22:85:78:87:86
4.	set ip	Setup the IP configuration of this device		Command sent: >set ip Response: Enter Host Name: PR-0602 Enter IP type. Type D for DHCP, or S for Static IP and then Enter:S Enter IP Address: 192.168.1.2->192.168.1.2 Enter Subnet Mask: 255.255.0.0->255.255.255.0 Enter Gateway IP: 192.168.1.1->192.168.1.1 --You have entered: Host Name PR-0602 Type Static IP IP Address 192.168.1.2 Subnet Mask 255.255.255.0 Gateway IP 192.168.1.1

				<p>Is this correct? Type Y or N and Enter ->y Settings written. Device must be rebooted to enable new settings.</p> <p>>--Current device friendly name:PR-0602 >--Current IP mode: static >--Current IP Address: 192.168.1.2 >--Current Subnet Mask: 255.255.255.0 >--Current Gateway IP: 192.168.1.1</p>
5.	get dns	Get device's DNS address		<p>Command sent: >get dns</p> <p>Response: DNS Servers ----- Domain suffix: amx.com Entry 1: 8.8.8.8 Entry 2: 8.8.4.4 Entry 3: 9.9.9.9</p>
6.	set dns	Set device's DNS address		<p>Command sent: >set dns</p> <p>Response: Enter Domain Suffix: amx.com Enter DNS Entry 1 : 192.168.20.5 Enter DNS Entry 2 : 12.18.110.8 Enter DNS Entry 3 : 12.18.110.7 You have entered: Domain Name: amx.com DNS Entry 1: 192.168.20.5 DNS Entry 2: 12.18.110.8 DNS Entry 3: 12.18.110.7 Is this correct? Type Y or N and Enter ->y Settings written. Device must be rebooted to enable new settings.</p> <p>>--Current Domain Name: amx.com >--Current DNS Entry 1: 192.168.20.5 >--Current DNS Entry 2: 12.18.110.8 >--Current DNS Entry 3: 12.18.110.7</p>
7.	get ethernet mode	Get ethernet mode		<p>Command sent: >get ethernet mode</p> <p>Response: --Current ethernet mode : 10 half</p>
8.	set ethernet mode	Set ethernet mode		<p>Command sent:</p>

		to auto, 100full or 10 half		<p>>set ethernet mode</p> <p>Response:</p> <p>Current ethernet mode : 10 half</p> <p>Enter new ethernet mode(Auto, 100 full or 10 half) -</p> <p>>Auto</p> <p>Would you like to set the ethernet mode (y/n):y</p> <p>New ethernet mode set, reboot the device for the change to take effect.</p> <p>>--Current ethernet mode : auto</p>
9.	renew dhcp	Renew the DHCP lease (may cause telnet disconnection)		<p>Command sent:</p> <p>>renew dhcp</p> <p>Response:</p> <p>You may need to re-establish the telnet session since the device will re-acquire an IP address lease.</p> <p>>--Current IP Address: 0.0.0.0</p> <p>>--Current Subnet Mask: 0.0.0.0</p> <p>>--Current Gateway IP: 0.0.0.0</p> <p>>--Current IP Address: 192.168.5.149</p> <p>>--Current Subnet Mask: 255.255.255.0</p> <p>>--Current Gateway IP: 192.168.5.254</p>

Security Commands (Telnet only)

No.	Command	Description	Variables	Example
1.	set telnet port	<p>Set the device's IP port listened to for Telnet connections</p> <p><u>NOTE: This command requires a reboot to enable new settings</u></p> <p><u>IMPORTANT: If you set the Telnet port to "0" to disable it, you will need to reset it in WebGUI</u></p>		<p>Command sent: >set telnet port</p> <p>Response: Current telnet port number = 23 Enter new telnet port number(0 = disable telnet) ->23 Setting telnet port number to 0 New telnet port number set, reboot the device for the change to take effect. >--Current telnet port: 23</p>
2.	set telnet username	<p>Set the Username for a secure Telnet session</p> <p>Default = blank (no username required)</p>		<p>Command sent: >set telnet username</p> <p>Response: Enter Telnet new username ->123 Would you like to set this username (y/n) ->y (please set telnet password) Changed && Saved</p>
3.	set telnet password	<p>Set the Username for a secure Telnet session</p> <p>Default = blank (no username required)</p>		<p>Command sent: >set telnet password</p> <p>Response: Enter Telnet new password ->123 Would you like to set this password (y/n) ->y Changed && Saved</p>
4.	set ssh port	<p>Set the device's IP port listened to for SSH connections</p> <p><u>NOTE: This command requires a reboot to enable new settings</u></p> <p><u>IMPORTANT: If you set the SSH port to "0" to disable it,</u></p>		<p>Command sent: >set ssh port</p> <p>Response: Current SSH port number = 22 Enter new SSH port number(0 = disable ssh) ->22 Setting SSH port number to 22 New SSH port number set, reboot the device for the change to take effect. >--Current SSH port: 22</p>

		<p><u>you will need to reset it in WebGUI</u></p> <p><u>NOTE: This command is supported by SSH only, not supported by telnet</u></p>		
5.	set ssh username	<p>Set the Username for a secure SSH session</p> <p><u>NOTE: This command is supported by SSH only, not supported by telnet</u></p>		<p>Command sent: >set ssh username</p> <p>Response: Enter SSH new username ->123 Would you like to set this username (y/n) ->y (please set SSH password) Changed && Saved</p>
6.	set ssh password	<p>Set the Username for a secure SSH session</p> <p><u>NOTE: This command is supported by SSH only, not supported by telnet</u></p>		<p>Command sent: >set ssh password</p> <p>Response: Enter SSH new password ->123 Would you like to set this password (y/n) ->y Changed && Saved</p>

Configuration Commands-Input

No.	Command	Description	Variables	Example
1.	get vidin portname:<input channel>	Get the name of the specified input	<input channel> = 1~8	Command sent: >get vidin portname:1 Response: Input port 1 named as Input 1
2.	set vidin portname:<input channel>,<name>	Set the name of the specified input	<input channel> = 1~8 <name> = name string	Command sent: >set vidin portname:1,blueray Response: set input port 1 named as blueray
3.	get vidin hdcpc:<input channel>	Get the HDCP mode for the specified input	<input channel> = 1~8	Command sent: >get vidin hdcpc:1 Response: get HDCP compliance on for input port 1
4.	set vidin hdcpc:<input channel>,<hdcpc_co mpliance>	Set the HDCP mode for the specified input	<input channel> = 1~8 <hdcpc_compliance> = on/off	Command sent: >set vidin hdcpc:1,Off Response: set HDCP compliance on for input port 1
5.	get vidin res:<input channel>	Get input video resolution for the specified input	<input channel> = 1~8 <resolution> = <H>x<V><i/p>,<Rat e><Specific Info>	Command sent: >get vidin res:1 Possible responses: ▪ get 1920x1080p,60 video input 1 ▪ get no video input 1
6.	get vidin status:<input channel>	Get input video status for the specified input <u>NOTE: This command used for unsolicited feedback and signal presence only on PR Matrix Switchers.</u>	<input channel> = 1~8 <status> = { VALID SIGNAL NO SIGNAL }	get vidin status:1 Possible response message include: ▪ get valid signal on input 1 ▪ get no signal on input 1
7.	get vidin edidmode:<input channel>	Get edid mode for the specified input	<input channel> = 1~8	Command sent: >get vidin edidmode:1 Response: get input 1 edid mode set to all hd resolutions

8.	set vidin edidmode:<input channel>,<edid_m ode>	Set edid mode for the specified input	<input channel> = 1~8 <edid_mode> = { Auto All HD RESOLUTIONS HD WIDE SCREEN HD FULL SCREEN 4K 4K60 Custom }	Command sent: >set vidin edidmode:1,4k Response: set input 1 to 4k edid mode >set preferred edid to 3840x2160p,30 for input 1
9.	get vidin prefedid:<input channel>	Get preferred resolution in the current edid used for the specified input, no matter it is under which EDID mode	<input channel> = 1~8 <resolution> = <H>x<V><i/p>,<Rat e><Specific Info>	Command sent: >get vidin prefedid:1 Response: get preferred edid set to 3840x2160p,30 for input 1
10.	set vidin prefedid:<input channel>,<edid>	Set preferred edid for the specified input	<input channel> = 1~8 <edid>= <H>x<V><i/p>,<Rat e><Specific Info> { (refer to AMX EDID Library) 640x400,85 640x480,60 640x480,72 640x480,75 640x480,85 720x400,85 720x480p,60 720x480p,120 720x480p,240 720x576p,50 720x576p,100 720x576p,200	Command sent: >set vidin prefedid:1,1920x1200p,60 Response: set preferred edid to 1920x1080p,60 for input 1

			800x600,56	
			800x600,60	
			800x600,72	
			800x600,75	
			800x600,85	
			848x480,60	
			848x480,75	
			848x480,85	
			1024x640,60	
			1024x768,60	
			1024x768,70	
			1024x768,75	
			1024x768,85	
			1152x864,75	
			1280x720,50	
			1280x720,60	
			1280x720p,60	
			1280x720p,100	
			1280x720p,120	
			1280x768,59	
			1280x768,60	
			1280x768,74	
			1280x768,75	
			1280x768,85	
			1280x800,60	
			1280x960,60	
			1280x960,85	
			1280x1024,60	
			1280x1024,75	
			1280x1024,85	
			1360x764,60	
			1360x768,60	
			1440x900,60	
			1440x900,75	
			1440x900,85	
			1400x1050,60	
			1400x1050,75	
			1600x1200,60	
			1680x1050,60	
			1920x1080i,50	
			1920x1080i,60	

			1920x1080p,24 1920x1080p,25 1920x1080p,30 1920x1080p,50 1920x1080,60 1920x1080p,60 1920x1200,59 1920x1200,60 3840x2160p,24 3840x2160p,25 3840x2160p,30 4096x2160p,24 4096x2160p,25 4096x2160p,30 3840x2160p,50 3840x2160,50 3840x2160p,60 3840x2160p,60CVR 4096x2160p,50 4096x2160p,60 }	
11.	get vidin ediddata:<input channel>	Get the current edid data used for the specified input port	<input channel> = 1~8	Command sent: >get vidin ediddata:1 Response: >get vidin ediddata:1 get ediddata for input 1 is: 00 FF FF FF FF FF FF 00 05 B8 00 18 02 00 00 00 20 1E 01 03 80 00 00 78 0E EE 95 A3 54 4C 99 26 0F 50 54 FF FF 80 D1 00 B3 00 A9 40 81 00 81 C0 81 80 8B C0 95 00 02 3A 80 18 71 38 2D 40 58 2C 45 00 40 84 63 00 00 1E 02 3A 80 18 71 38 2D 40 58 2C 45 00 40 84 63 00 00 1E 00 00 00 FD 00 17 78 0F 87 3C 00 0A 20 20 20 20 20 20 00 00 00 FC 00 41 4D 58 5F 48 44 4D 49 31 30 76 32 0A 01 92 02 03 3A 70 6E 03 0C 00 11 00 80 3C 20 00 80 01 02 03 04 67 D8 5D C4 01 78 80 00 57 61 60 5F 5E 5D 64 62 63 10 20 22 1F 21 05 14 04 03 13 07 12 16 27 01 E2 0F 03 23 09 07 07 D1 3D 80 80 72 B0 26 40 78 C8 36 00 40 E8 63 00 00 1C 28 3C 80 A0 70 B0 23 40 30 20 36 00 40 E8 63 00 00 1A 00 7A

12.	<p>set vidin ediddata:<input channel>,<edid_data></p>	<p>Set edid data for the specified input channel as custom edid</p> <p><u>NOTE: EDID mode will be set to Custom automatically when uploading edid by the command</u></p>	<p><input channel> = 1~8 <edid_data> = 256byte EDID Data</p>	<p>Command sent:</p> <pre>>set vidin ediddata:1,00 FF FF FF FF FF FF 00 05 B8 00 18 02 00 00 00 20 1E 01 03 80 00 00 78 0E EE 95 A3 54 4C 99 26 0F 50 54 FF FF 80 D1 00 B3 00 A9 40 81 00 81 C0 81 80 8B C0 95 00 04 74 00 30 F2 70 5A 80 B0 58 8A 00 40 84 63 00 00 1E 02 3A 80 18 71 38 2D 40 58 2C 45 00 40 84 63 00 00 1E 00 00 00 FD 00 17 78 0F 87 3C 00 0A 20 20 20 20 20 20 00 00 00 FC 00 41 4D 58 5F 48 44 4D 49 31 30 76 32 0A 01 CF 02 03 38 70 6E 03 0C 00 11 00 80 3C 20 00 80 01 02 03 04 67 D8 5D C4 01 78 80 00 55 5D 5F 5E 64 62 63 10 20 22 1F 21 05 14 04 03 13 07 12 16 27 01 E2 0F 03 23 09 07 07 D1 3D 80 80 72 B0 26 40 78 C8 36 00 40 E8 63 00 00 1C 28 3C 80 A0 70 B0 23 40 30 20 36 00 40 E8 63 00 00 1A 00 3F</pre> <p>Response:</p> <pre>>set input 1 to custom edid mode and custom edid data to be: 00 FF FF FF FF FF FF 00 05 B8 00 18 02 00 00 00 20 1E 01 03 80 00 00 78 0E EE 95 A3 54 4C 99 26 0F 50 54 FF FF 80 D1 00 B3 00 A9 40 81 00 81 C0 81 80 8B C0 95 00 04 74 00 30 F2 70 5A 80 B0 58 8A 00 40 84 63 00 00 1E 02 3A 80 18 71 38 2D 40 58 2C 45 00 40 84 63 00 00 1E 00 00 00 FD 00 17 78 0F 87 3C 00 0A 20 20 20 20 20 20 00 00 00 FC 00 41 4D 58 5F 48 44 4D 49 31 30 76 32 0A 01 CF 02 03 38 70 6E 03 0C 00 11 00 80 3C 20 00 80 01 02 03 04 67 D8 5D C4 01 78 80 00 55 5D 5F 5E 64 62 63 10 20 22 1F 21 05 14 04 03 13 07 12 16 27 01 E2 0F 03 23 09 07 07 D1 3D 80 80 72 B0 26 40 78 C8 36 00 40 E8 63 00 00 1C 28 3C 80 A0 70 B0 23 40 30 20 36 00 40 E8 63 00 00 1A 00 3F</pre> <p>>set input 1 to custom edid mode</p>
-----	---	---	--	--

Configuration Commands-Output

No.	Command	Description	Variables	Example
1.	get vidout portname:<output channel>	Get the name of the specified output port	<output channel> = 1~8	Command sent: >get vidout portname:1 Response: output 1 is named as meeting room 1
2.	set vidout portname:<output channel>,<name>	Set the name of the specified output port	<output channel> = 1~8 <name> = name string	Command sent: >set vidout portname:1,Meeting Room 2 Response: output 1 is named as meeting room 2
3.	get vidout hdcp:<output channel>	Get HDCP mode for the specified output	<output channel> = 1~8	Command sent: >get vidout hdcp:1 Response: output 1 is set to AUTO HDCP mode
4.	set vidout hdcp:<output channel>,<hdcp_mode>	Set HDCP mode for the specified output	<output channel> = 1~8 <hdcp_mode> = { AUTO HDCP2.2 HDCP1.4 NO-HDCP }	Command sent: >set vidout hdcp:1,hdcp2.2 Response: output 1 is set to HDCP2.2 mode
5.	get vidout res:<output channel>	Get video resolution for the specified output	<output channel> = 1~8 <resolution> = <H>x<V><i/p>,<Rate><Specific Info>	Command sent: >get vidout res: Possible response message include: ▪ output 1 resolution is 4096x2160p,60 ▪ output 1 resolution is no signal
6.	get vidout osd	Get osd enable state for video output		Command sent: >get vidout osd Response: get osd on for video output
7.	set vidout osd:<state>	Set osd enable state for video output	<state>= on/off	Command sent: >set vidout osd:off Response: set osd off for video output
8.	get vidout osd color	Get osd color setting for video output		Command sent: >get vidout osd color Response: get osd color set to black
9.	set vidout osd color:<color>	Set osd color setting for video output	<color>= black/blue	Command sent: >set vidout osd color:blue

				Response: set osd color to blue
10.	get vidout osd pos	Get osd position for video output		Command sent: >get vidout osd pos Response: get osd pos set to top left
11.	set vidout osd pos:<position>	Set osd position for video output	<position>= { TR (Top Right) TL (Top Left) BR (Bottom Right) BL (Bottom Left) C (Center) }	Command sent: >set vidout osd pos:tr Response: set osd pos to top right
12.	get vidout cec power:<output channel>	Get current power status from the sink via CEC		Command sent: >get vidout cec power:1 Possible responses: ▪ get cec on for sink on output 1 ▪ get cec fail for sink on output 1 ▪ No attached sink
13.	set vidout cec power:<output channel>,<state>	Set power status on/off for the sink device via CEC	<output channel>= 1~8 <state>=on/off	Command sent: >set vidout cec power:1,on Possible responses: ▪ set cec on for sink on output 1 ▪ No attached sink
14.	set vidout cec standby:<output channel>	Set power standby for the sink device via CEC on specified output port	<output channel>= 1~8	Command sent: >set vidout cec standby:1 Possible responses: ▪ set power standby for sink on output 1 ▪ No attached sink
15.	set vidout cec makeactive:<output channel>	Make active for the sink device via CEC on specified output port	<output channel>= 1~8	Command sent: >set vidout cec makeactive:1 Possible responses: ▪ make active for sink on output 1 ▪ No attached sink
16.	get vidout cec disp auto:<output channel>	Get cec display auto on/off state for specified output	<output channel>= 1~8	Command sent: >get vidout cec disp auto:2 Response: get cec display auto on for output 2
17.	set vidout cec disp auto:<output channel>,<state>	Set cec display auto on/off state for specified output	<output channel>= 1~8 <state>= on/off	Command sent: >set vidout cec disp auto:2,on Response:

				set cec display auto off for output 2
18.	get vidout cec sleep timeout:<output channel>	Get cec display auto on/off delay time for specified output	<output channel>= 1~8	Command sent: >get vidout cec sleep timeout:2 Response: get cec sleep timeout set to 2mins for output 2
19.	set vidout cec sleep timeout:<output channel>,<time>	Set cec display auto on/off delay time for specified output	<output channel>= 1~8 <time>= 1~30 minutes	Command sent: >set vidout cec sleep timeout:2,5 Response: set cec sleep timeout set to 5mins for output 2
20.	get vidout mute:<output channel>	Get video mute state for specified output	<output channel>= 1~8, only for PR-0402/0404/0602/0808	Command sent: >get vidout mute:1 Response: get video mute off for output 1
21.	set vidout mute:<output channel>,<state>	Set video mute for specified output	<output channel>= 1~8, only for PR-0402/0404/0602/0808 <state>= on/off	Command sent: >set vidout mute:1,on Response: set video mute on for output 1
22.	get vidout blank:<output channel>	get video blank setting for specified output	<output channel>= 1~8, only for PR-0402/0404/0602/0808	Command sent: >get vidout blank:1 Response: get video blank set to black for output 1
23.	set vidout blank:<output channel>,<pattern> >	set vidout blank setting for specified output <u>NOTE: When select to LOGO, the LOGO is fix in center</u>	<output channel>= 1~8, only for PR-0402/0404/0602/0808 <pattern>= { black (no blank color) red green blue }	Command sent: >set vidout blank:1,red Response: set video blank to red for output 1
24.	get vidout sleep:<output channel>	Get vidout tmds sleep on/off setting for specified output	<output channel>= 1~8	Command sent: >get vidout sleep:1 Response: get video sleep on for output 1
25.	set vidout sleep:<output channel>,<state>	Set vidout tmds sleep on/off setting for specified output	<output channel>= 1~8 <state>= on/off	Command sent: >set vidout sleep:1,off Response:

				set video sleep off for output 1
26.	get vidout sleep delay:<output channel>	Get vidout tmds sleep on/off delay time setting for specified output	<output channel>= 1~8	Command sent: >get vidout sleep delay:1 Response: get video sleep off delay time set to 1800 seconds for output 1
27.	set vidout sleep delay:<output channel>,<time>	Set vidout tmds sleep on/off delay time setting for specified output	<output channel>= 1~8 <time>= 0~1800 seconds	Command sent: >set vidout sleep delay:1,0 Response: set video sleep off delay time to 0 seconds for output 1
28.	get audout mute:<output channel>	Get audio mute state for the specified output	<output channel>= 1~8	Command sent: >get audout mute:1 Response: get audio mute set to on for output 1
29.	set audout mute:<output channel>,<state>	Set audio mute for the specified output Enable or disable audio muting on the ports specified by AUDOUT_FORMAT, The mute state works as follows: Setting: AUDOUT_MUTE = ENABLE AUDOUT_FORMAT - HDMI (HDMI audio muted, AUDIO OUT audio off) AUDOUT_FORMAT - ANALOG (HDMI audio off, AUDIO OUT audio muted) AUDOUT_FORMAT - ALL (HDMI audio muted, AUDIO OUT audio muted)	<output channel>= 1~8 <state>= on/off	Command sent: >set audout mute:1,on Response: set audio mute to on for output 1

		<p>Setting:</p> <p>AUDOUT_MUTE = DISABLE</p> <p>AUDOUT_FORMAT - HDMI (HDMI audio plays, AUDIO OUT audio off)</p> <p>AUDOUT_FORMAT - ANALOG (HDMI audio off, AUDIO OUT audio plays)</p> <p>AUDOUT_FORMAT - ALL (HDMI audio plays, AUDIO OUT audio plays)</p>		
30.	get audout format:<output channel>	Get audio output format for the specified output	<output channel>= 1~8	<p>Command sent:</p> <p>>get audout format:1</p> <p>Response:</p> <p>get audio format set to all for output 1</p>
31.	set audout format:<output channel>,<format>	<p>Set audio output format for the specified output</p> <p>Audio format option</p> <p>ALL - There are both Digital Audio embedded in HDMI OUT port and Analog Audio in AUDIO OUT port</p> <p>HDMI - Set Digital Audio embedded in HDMI OUT port is ON, Analog Audio in ANALOG OUT port is OFF</p> <p>ANALOG - Set Digital Audio embedded in HDMI OUT port is OFF,</p>	<p><output channel>= 1~8</p> <p><format>=</p> <pre>{ all hdmi analog }</pre>	<p>Command sent:</p> <p>>set audout format:1,hdmi</p> <p>Response:</p> <p>set audio format to hdmi for output 1</p>

		<p>Analog Audio in ANALOG OUT port is ON</p> <p><u>NOTE: When HDMI embedded audio is not PCM audio (such as compressed Dolby/DTS audio), auto MUTE Analog line out, even ALL and ANALOG format is selected</u></p>		
32.	get vidout ediddata:<output channel>	Get edid data for the sink on specified output	<output channel>= 1~8	<p>Command sent: >get vidout ediddata:1</p> <p>Response: get edid data from output 1: 00 FF FF FF FF FF 00 10 AC 5C F0 4D 50 37 41 11 18 01 03 80 3E 22 78 EA 0A A5 A2 57 4F A2 28 0F 50 54 A5 4B 00 71 4F 81 00 81 80 A9 40 B3 00 D1 C0 D1 00 01 01 04 74 00 30 F2 70 5A 80 B0 58 8A 00 6D 55 21 00 00 1E 00 00 00 FF 00 57 4A 4A 47 52 34 34 50 41 37 50 4D 0A 00 00 00 FC 00 44 45 4C 4C 20 50 32 38 31 35 51 0A 20 00 00 00 FD 00 18 55 1F 72 1E 00 0A 20 20 20 20 20 20 01 47 02 03 2D F1 52 90 1F 01 02 03 07 16 04 13 14 05 12 11 06 15 20 21 22 23 09 1F 07 83 01 00 00 6D 03 0C 00 10 00 00 3C 20 00 60 03 02 01 02 3A 80 18 71 38 2D 40 58 2C 45 00 6D 55 21 00 00 1E 01 1D 80 18 71 1C 16 20 58 2C 25 00 6D 55 21 00 00 9E 01 1D 00 72 51 D0 1E 20 6E 28 55 00 6D 55 21 00 00 1E 8C 0A D0 8A 20 E0 2D 10 10 3E 96 00 6D 55 21 00 00 18 00 00 00 00 00 00 00 00 00 86</p>

Switching Commands

No.	Command	Description	Variables	Example
1.	load preset:<preset mode>	Load the specified preset mode for switcher setting	<preset mode>= 1~8	Command sent: >load preset:1 Response: loaded preset 1 >set switch video from input 2 for output 1
2.	save preset:<preset mode>	Save current switcher setting as the specified preset mode	<preset mode>= 1~8	Command sent: >save preset:2 Response: saved current switcher as preset mode 2
3.	get preset name:<preset mode>	Get preset name for the specified preset mode	<preset mode>= 1~8	Command sent: >get preset name:2 Response: get Preset 2 as name for preset mode 2
4.	set preset name:<preset mode>,<name>	Set preset name for the specified preset mode	<preset mode>= 1~8 <name>= name string	Command sent: >set preset name:2,1toALL Response: set 1toALL as name for preset mode 2
5.	get auto switch	Get on or off auto switch input source for video output <u>NOTE: This command is only for PR-0402</u>	<state> = on/off	Command sent: >get auto switch Response: get auto switch on
6.	set auto switch:<state>	Set on or off auto switch input source for video output <u>NOTE: This command is only for PR-0402</u>	<state> = on/off	Command sent: >set auto switch:off Response: set auto switch off
7.	get switch VI<input channel>	Get which video outputs is switched to specified input	<input channel>= { 1~4 for PR-0402 and PR-0404, 1~6 for PR-0602, 1~8 for PR-0808 }	Command sent: >get switch VI1 Possible responses: • get switch video input 1 for all output • get switch video input 1 for no output • get switch video input 1 for output 1,2,3 • get switch video input 1 for window 1 • invalid

8.	get switch VO<channel>	Get which video input is switched to specified output	<channel>= { 1~2 for PR-0402 and PR-0602 Output Channel, 1~4 for PR-0404 Output Channel, 1~8 for PR-0808 Output Channel }	Command sent: >get switch VO2 Possible responses: <ul style="list-style-type: none"> ▪ get switch video input 1 for output 2 ▪ get switch no video input for output 2 ▪ get switch video input 1 for window 2 ▪ get switch no video input for window 2 ▪ invalid
9.	set switch VI<input channel>O<channel>	Set switch video for input port to the output port	<input channel>= { 0 for Selection of No input channel, 1~4 for PR-0402 and PR-0404, 1~6 for PR-0602 1~8 for PR-0808 } <channel>= { 0 for Selection of No channel, 1~2 for PR-0402 and PR-0602 Output Channel, 1~4 for PR-0404 Output Channel, 1~8 for PR-0808 Output Channel, all for Selection of ALL channel }	Possible command sent: <ul style="list-style-type: none"> ▪ set switch VI1OALL ▪ set switch VI0O1 ▪ set switch VI0O1,2,8 ▪ set switch VI2O1,2,3 ▪ set switch VI2O0 Possible responses: <ul style="list-style-type: none"> ▪ set switch video from input 1 for all output ▪ set switch video from no input for output 1 ▪ set switch video from no input for window 1 ▪ set switch video from no input for output 1, 2, 8 ▪ set switch video from input 2 for output 1,2,3 ▪ set switch video from input 2 for window 1,2,3 ▪ set switch video from input 2 for no output ▪ invalid switch
10.	get switch CI<input channel>	Get audio/video in specified input are switched to which outputs	<input channel>= { 1~4 for PR-0402 and PR-0404, 1~6 for PR-0602, 1~8 for PR-0808 }	Command sent: >get switch CI1 Possible response message include: <ul style="list-style-type: none"> ▪ get switch audio and video from input 1 for all output ▪ get switch audio and video from input 1 for output 2 ▪ get switch audio and video from input 1 for no output

11.	get switch CO<channel>	Get audio/video in specified output are switched from which inputs	<channel>= { 1~2 for PR-0402 and PR-0602 Output Channel, 1~4 for PR-0404 Output Channel, 1~8 for PR-0808 Output Channel }	Command sent: >get switch CO2 Possible responses: ▪get switch audio and video from input 1 for output 2 ▪get switch audio and video from no input for output 2
12.	set switch CI<input channel>O<channel>	Set switch both the audio and video input to the output port.	<input channel>= { 0 for Selection of No input channel, 1~4 for PR-0402 and PR-0404, 1~6 for PR-0602, 1~8 for PR-0808 } <channel>= { 0 for Selection of No channel, 1~2 for PR-0402 and PR-0602 Output Channel, 1~4 for PR-0404 Output Channel, 1~8 for PR-0808 Output Channel, all for Selection of ALL channel }	Possible command sent: ▪set switch CI1OALL ▪set switch CI0O1 ▪set switch CI0O1,2,8 ▪set switch CI2O1,2,3 ▪set switch CI2O0 Possible response message include: ▪set switch audio and video from input 1 for all output ▪set switch audio and video from no input for output 1 ▪set switch audio and video from no input for window 1 ▪set switch audio and video from no input for output 1,2,8 ▪set switch audio and video from input 2 for output 1,2,3 ▪set switch audio and video from input 2 for window 1,2,3 ▪set switch audio and video from input 2 for no output ▪invalid switch



© 2023 Harman. All rights reserved. SmartScale, NetLinX, Enova, AMX, AV FOR AN IT WORLD, and HARMAN, and their respective logos are registered trademarks of HARMAN. Oracle, Java and any other company or brand name referenced may be trademarks/registered trademarks of their respective companies. AMX does not assume responsibility for errors or omissions. AMX also reserves the right to alter specifications without prior notice at any time. The AMX Warranty and Return Policy and related documents can be viewed/downloaded at www.amx.com.
3000 RESEARCH DRIVE, RICHARDSON, TX 75082 AMX.com | 800.222.0193 | 469.624.8000 | +1.469.624.7400 | fax 469.624.7153
Last Revised: 2024-11-22