

REVISIONS				
REV	ECN NUMBER	DESCRIPTION	DATE	APPROVED
A	19135	DOCUMENT RELEASE	07-Feb-12	-

NOTES: UNLESS OTHERWISE SPECIFIED  
 1. DIMENSIONS IN [ ] ARE IN MILLIMETERS.

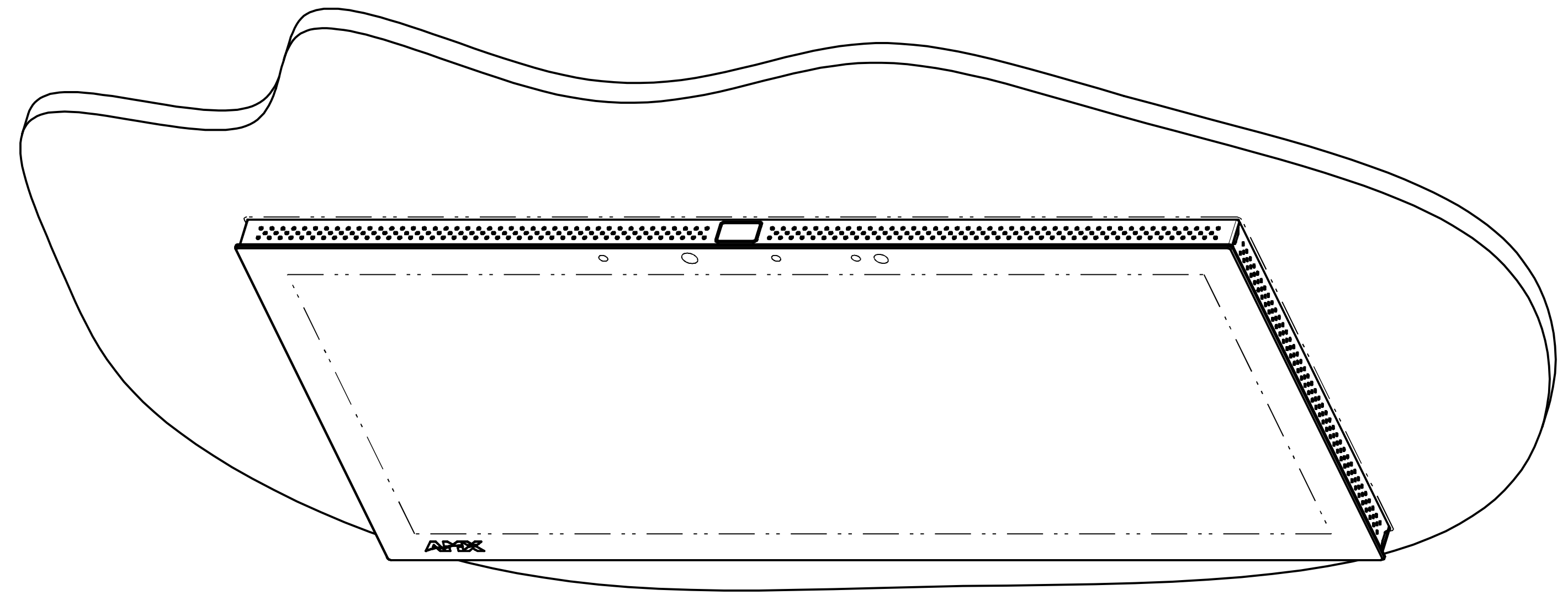
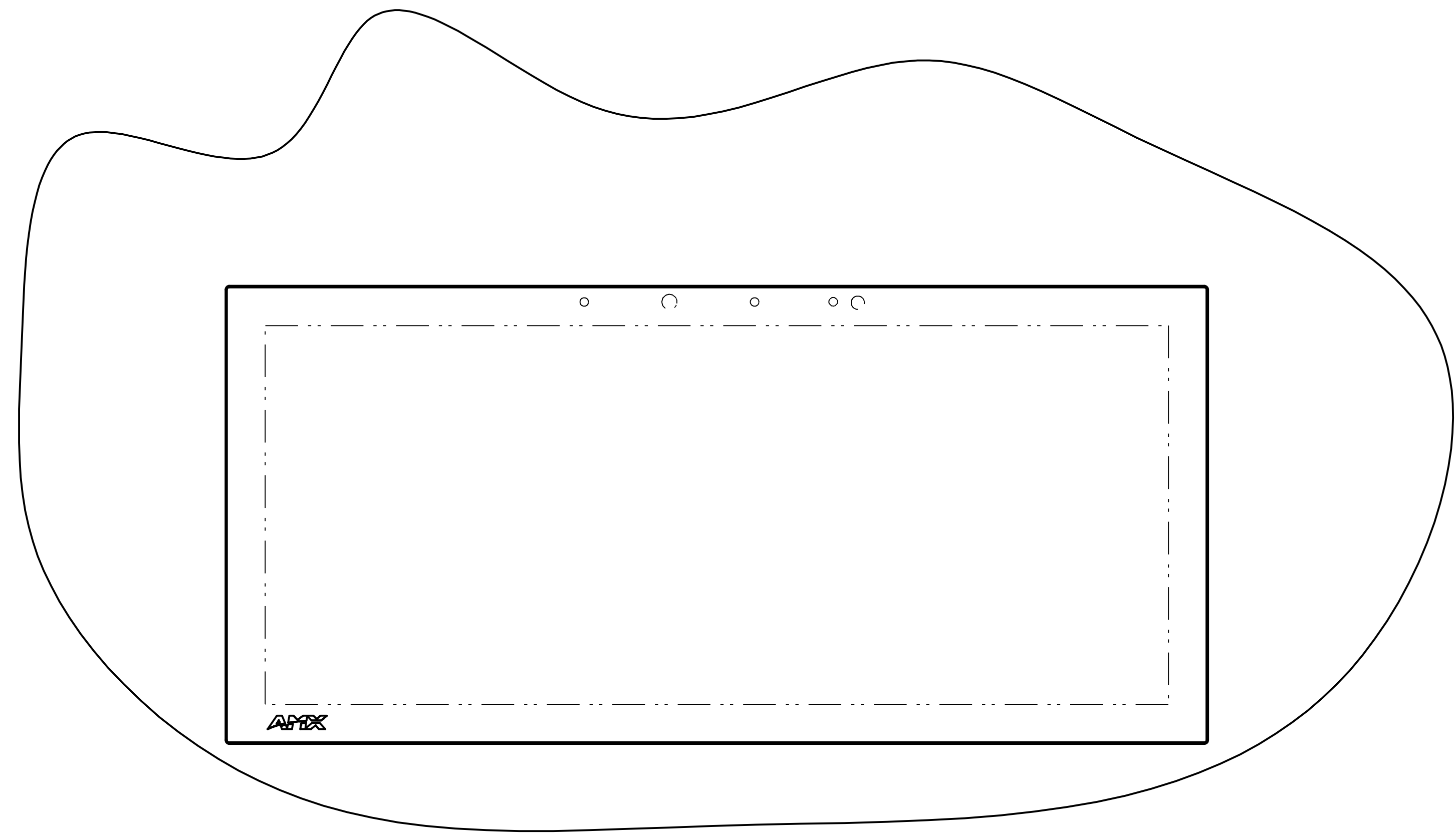

LANDSCAPE MOUNTING

UNLESS OTHERWISE STATED, THE ARTICLE SPECIFIED SHALL BE RoHS COMPLIANT PER EU DIRECTIVE 2002/95/EC

NOTICE: This drawing is the property of AMX LLC. All information contained herein this is not generally known shall be confidential except to the extent the information had been previously established. This drawings may not be copied, reproduced, or used as the basis for manufacture or sale without written permission.

UNLESS OTHERWISE SPECIFIED  
 TOLERANCE ON DECIMAL DIMENSIONS: .X = ±0.1  
 .XX = ±0.02  
 .XXX = ±0.010  
 ANGLES: ±1.0°  
 SURFACE FLATNESS .003 TIR PER LINEAR INCH  
 ALL DIMENSIONS IN INCHES.  
 DO NOT SCALE DRAWING

**AMX** AMX LLC  
 3000 RESEARCH DRIVE  
 RICHARDSON, TX 75082

MOUNTING SPECIFICATION,  
 MODERO 20.3" PANORAMIC  
 WALL TOUCH PANEL

SIZE <b>D</b>	DRAWING NUMBER SP5968-05	REV A
SCALE 1:2		SHEET 1 OF 4

1

2

3

4

1

2

3

4

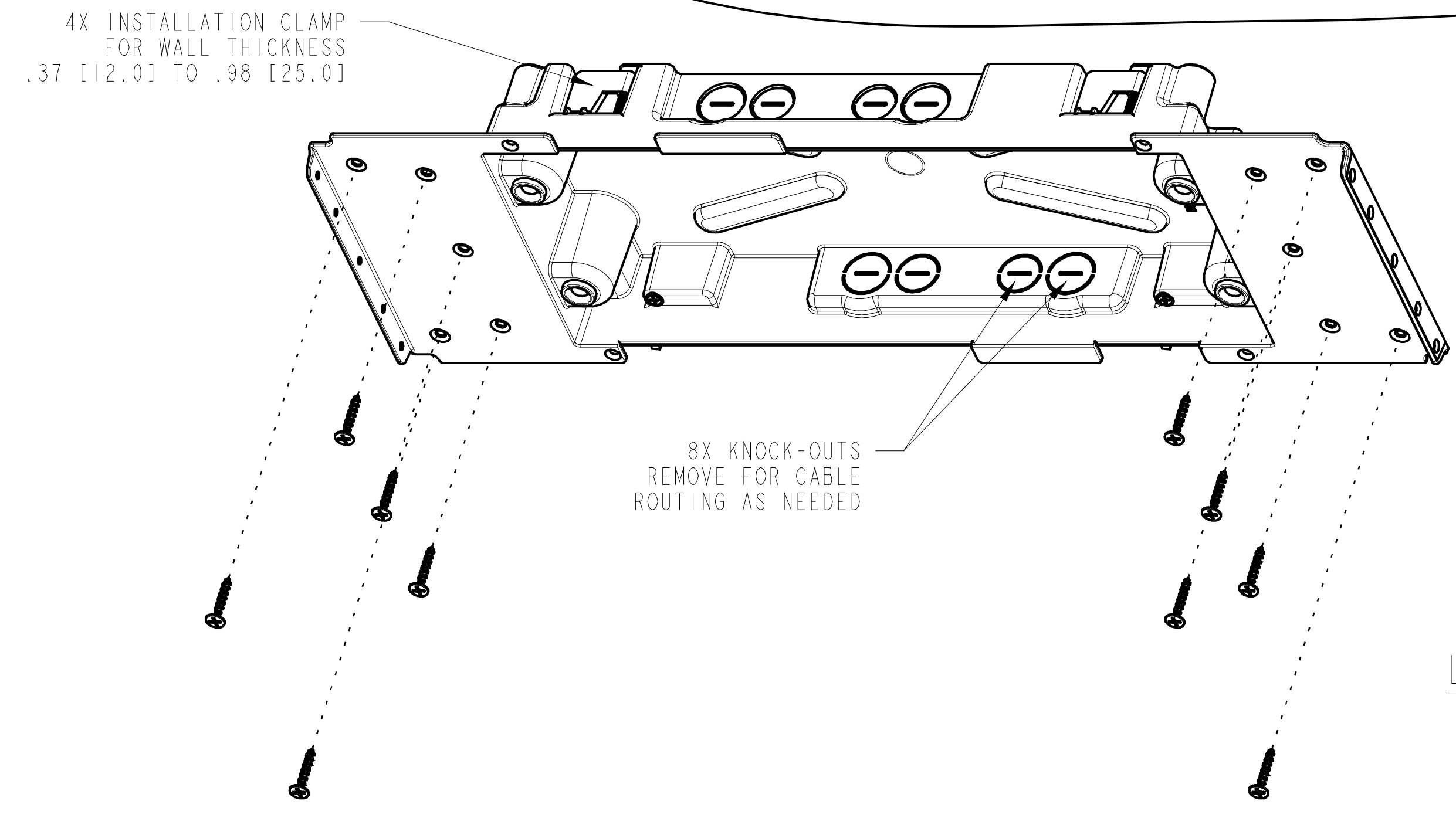
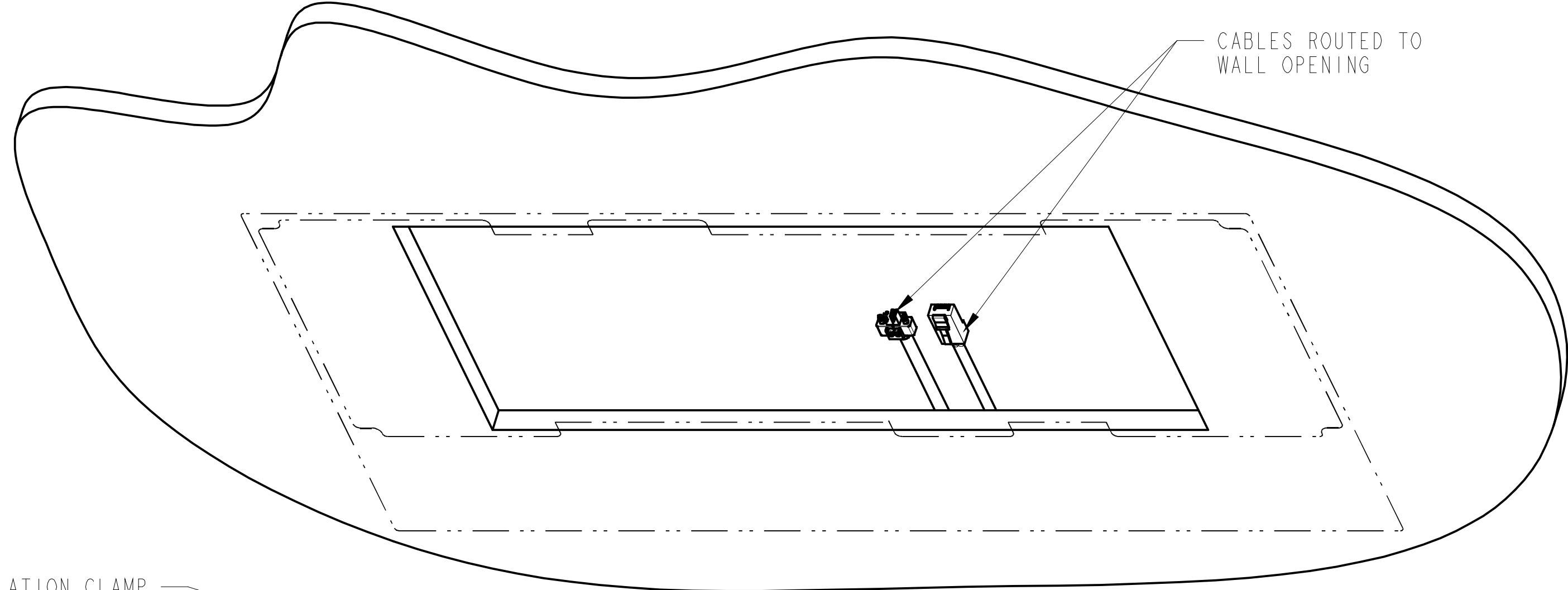
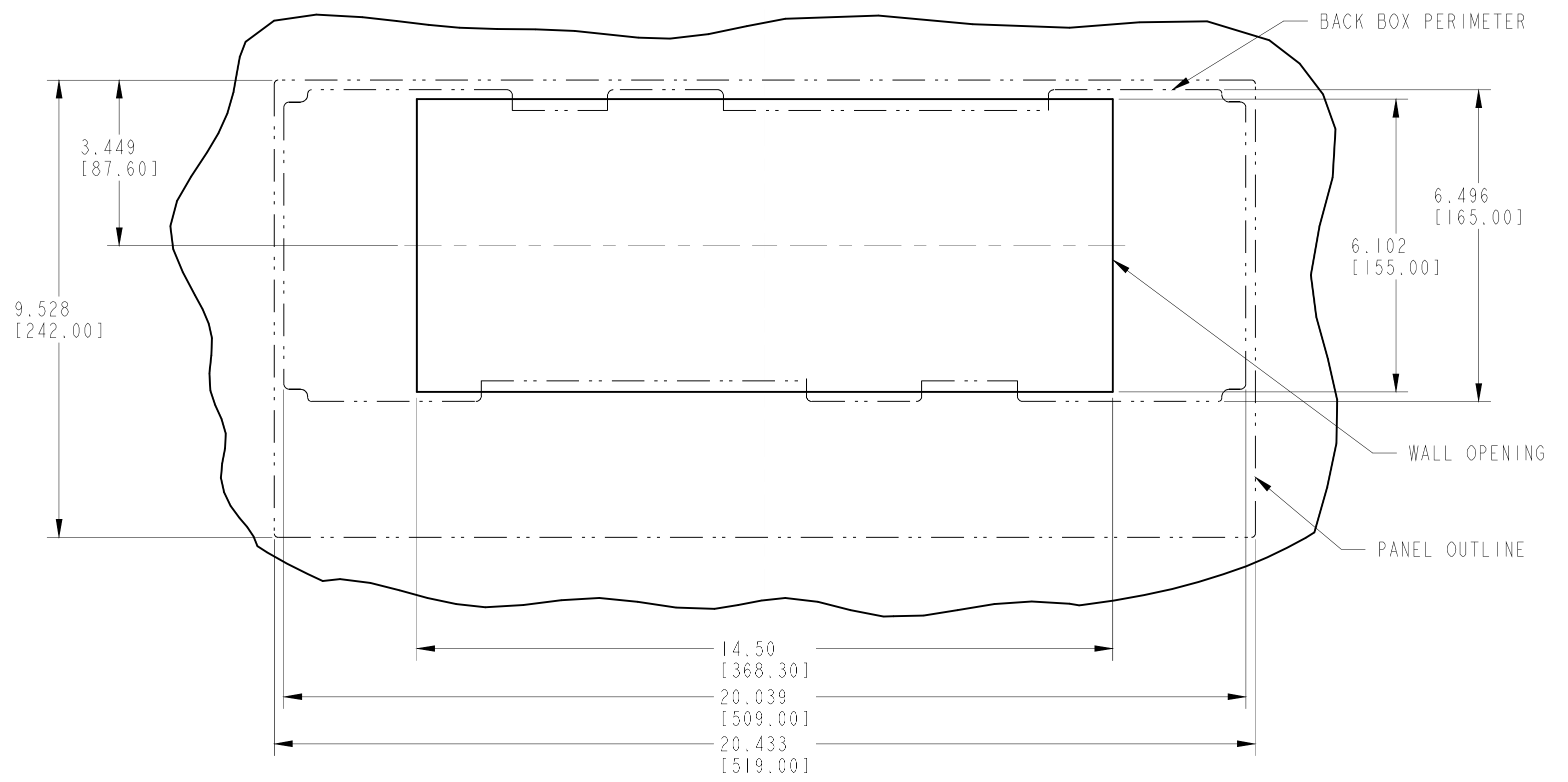

LANDSCAPE MOUNTING

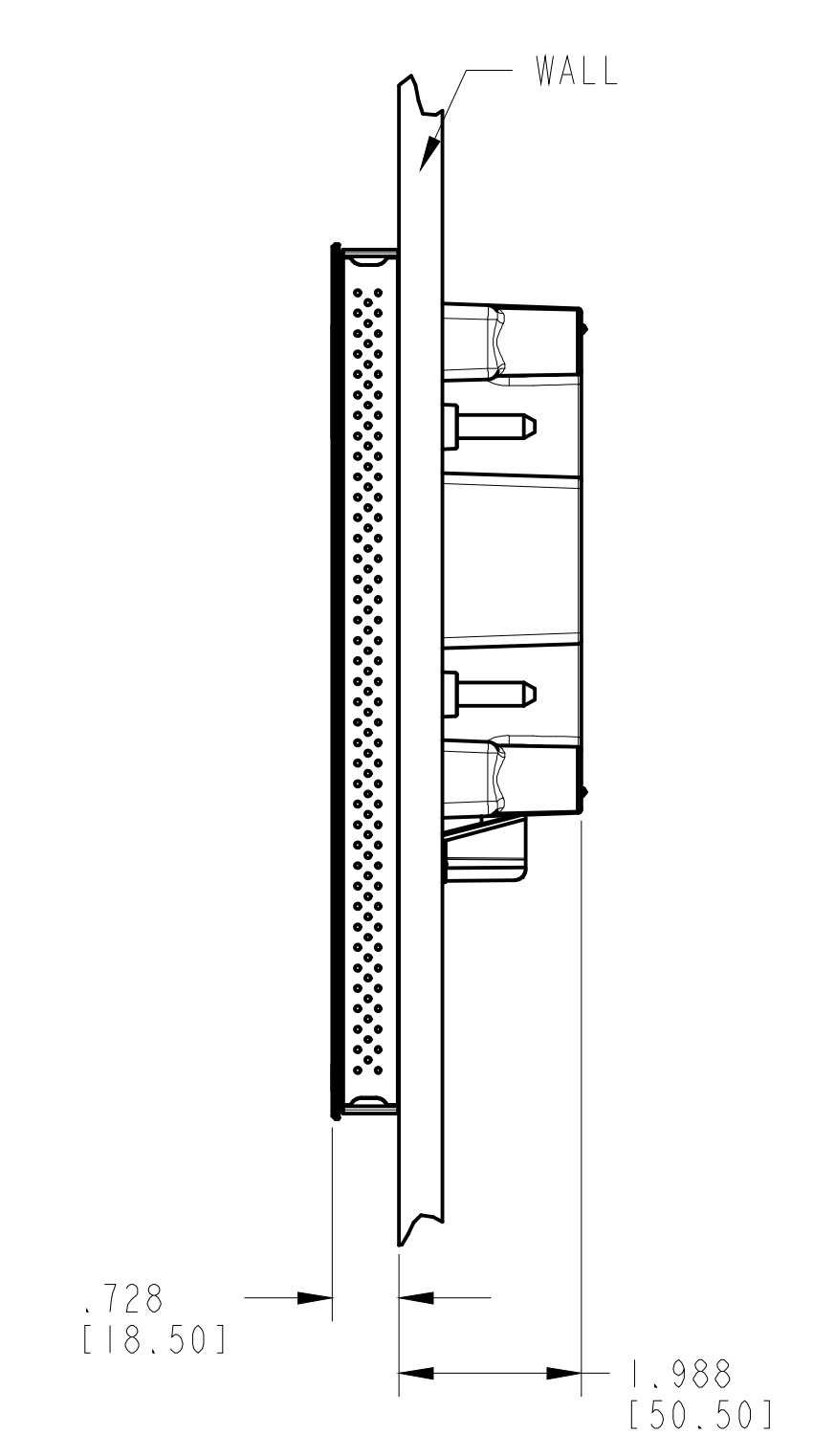
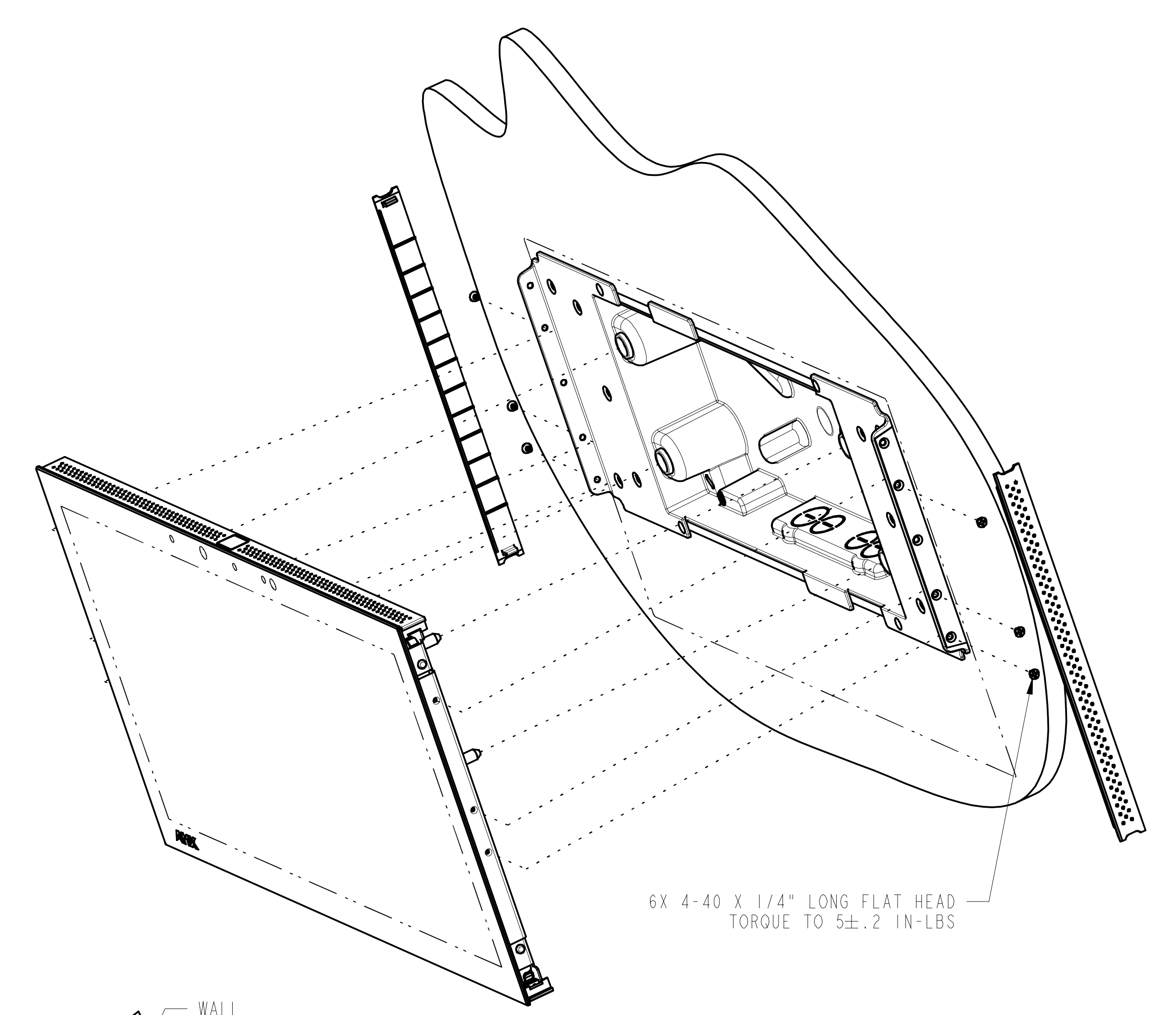

NOTICE: This drawing is the property of AMX LLC. All information contained herein this is not generally known shall be confidential except to the extent the information had been previously established. This drawings may not be copied, reproduced, or used as the basis for manufacture or sale without written permission.

**AMX** AMX LLC  
3000 RESEARCH DRIVE  
RICHARDSON, TX 75082

MOUNTING SPECIFICATION,  
MODERO 20.3" PANORAMIC  
WALL TOUCH PANEL

SIZE <b>D</b>	DRAWING NUMBER SP5968-05	REV A
SCALE 1:2	SHEET 2 OF 4	

A

B

C

D

E

F

SP5968-05

3

H

1

1

2

2

3

3

4

4

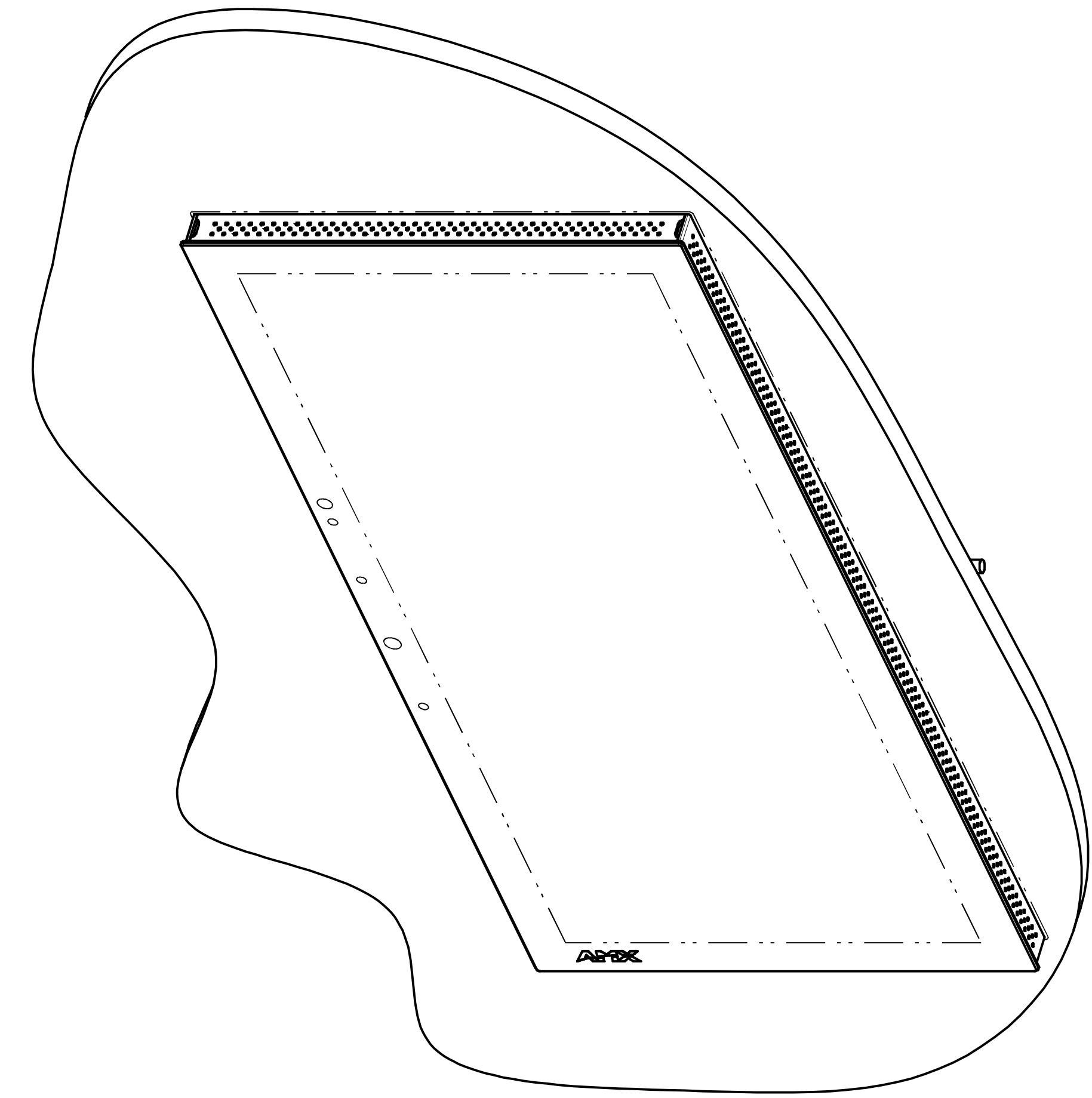
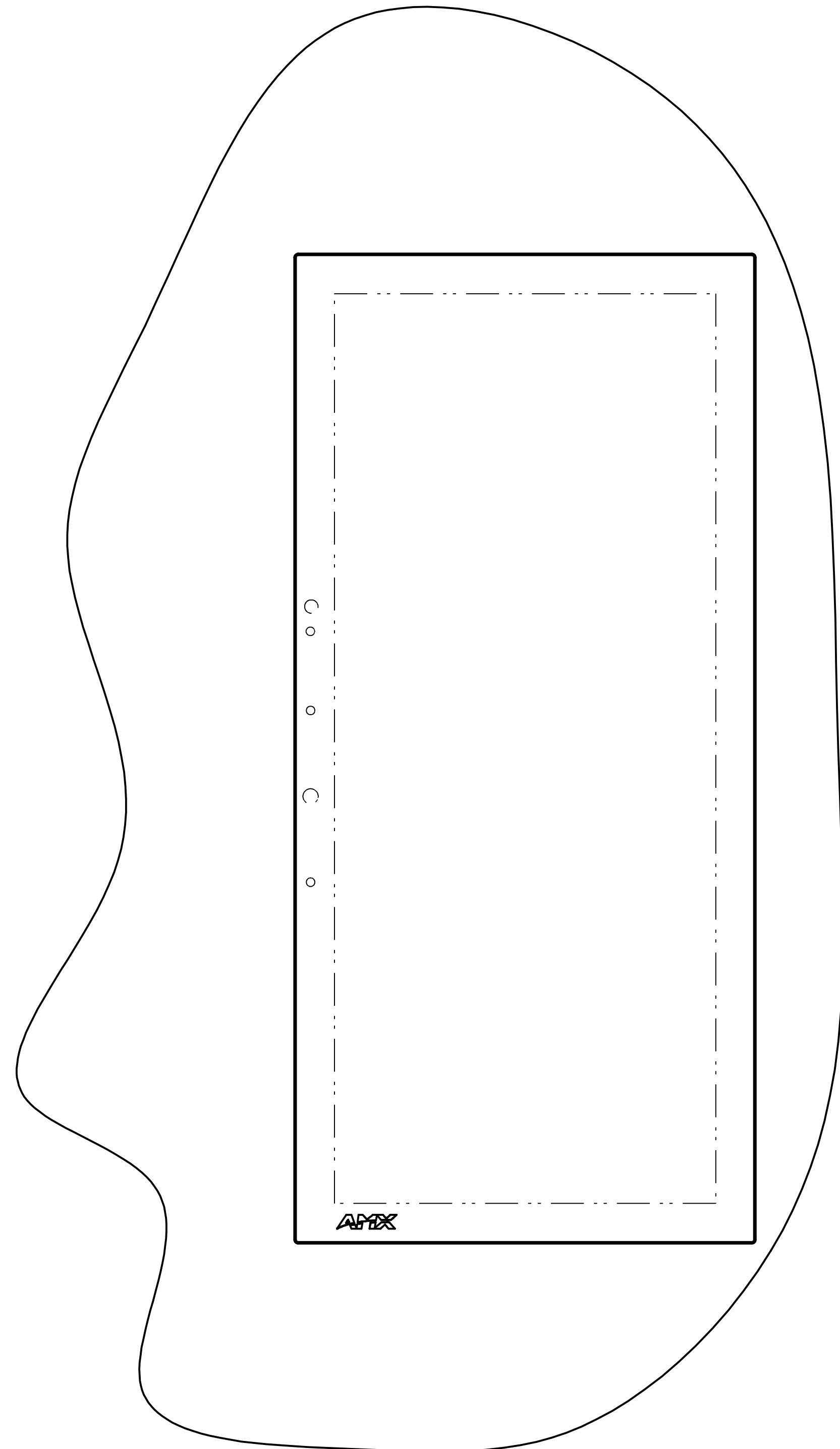

PORTRAIT MOUNTING

NOTICE: This drawing is the property of AMX LLC. All information contained herein this is not generally known shall be confidential except to the extent the information had been previously established. This drawings may not be copied, reproduced, or used as the basis for manufacture or sale without written permission.

<b>AMX</b>		AMX LLC 3000 RESEARCH DRIVE RICHARDSON, TX 75082	
MOUNTING SPECIFICATION, MODERO 20.3" PANORAMIC WALL TOUCH PANEL			
SIZE <b>D</b>	DRAWING NUMBER	SP5968-05	REV A
SCALE 1:2		SHEET 3 OF 4	

A

B

C

D

E

F

G

H

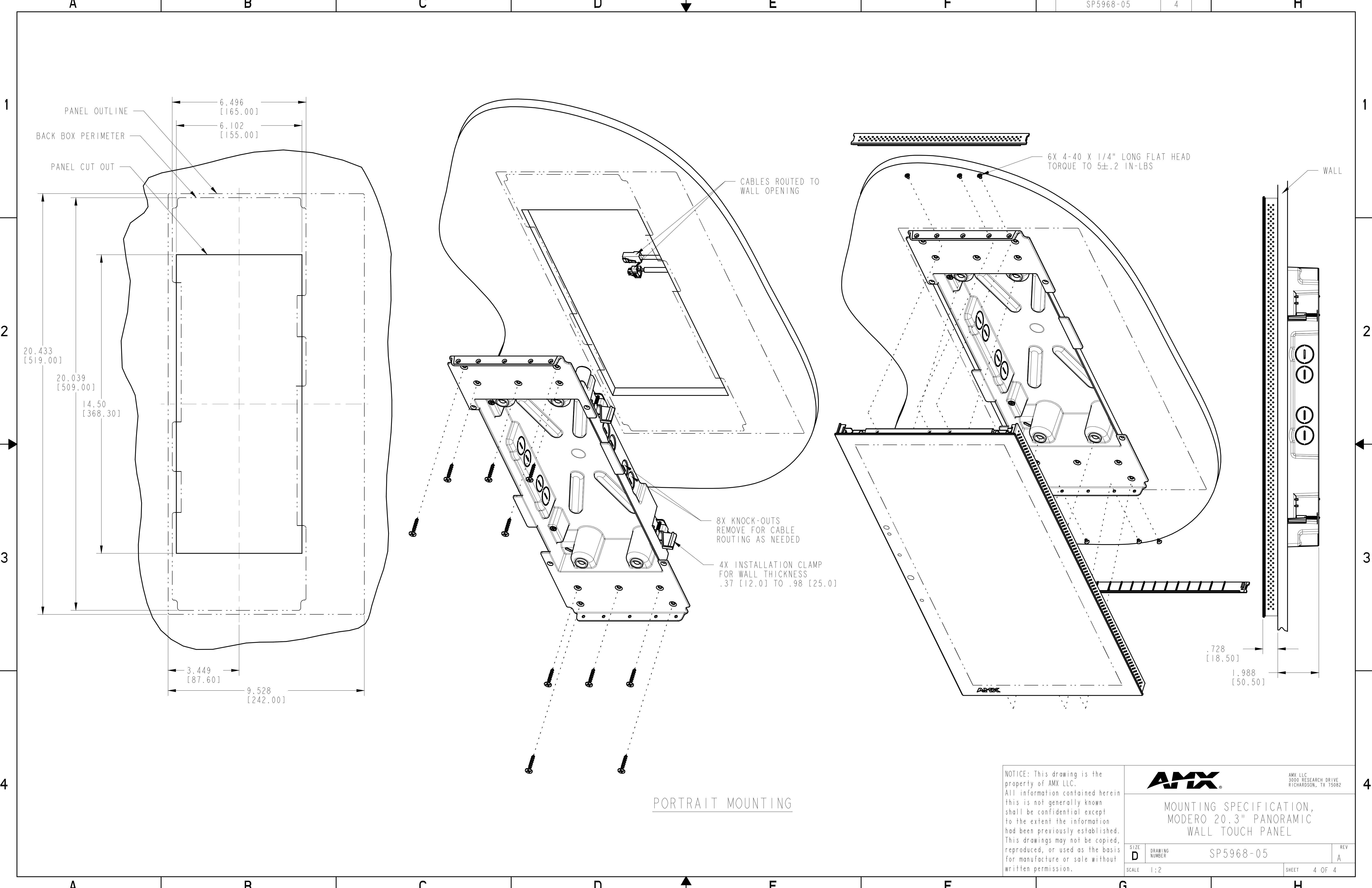

PANEL OUTLINE  
 BACK BOX PERIMETER  
 PANEL CUT OUT

6.496 [165.00]  
 6.102 [155.00]

20.433 [519.00]  
 20.039 [509.00]  
 14.50 [368.30]

3.449 [87.60]  
 9.528 [242.00]

CABLES ROUTED TO WALL OPENING

8X KNOCK-OUTS REMOVE FOR CABLE ROUTING AS NEEDED

4X INSTALLATION CLAMP FOR WALL THICKNESS .37 [12.0] TO .98 [25.0]

6X 4-40 X 1/4" LONG FLAT HEAD TORQUE TO 5±.2 IN-LBS

WALL

.728 [18.50]  
 1.988 [50.50]

PORTRAIT MOUNTING

NOTICE: This drawing is the property of AMX LLC. All information contained herein this is not generally known shall be confidential except to the extent the information had been previously established. This drawings may not be copied, reproduced, or used as the basis for manufacture or sale without written permission.

**AMX** AMX LLC  
 3000 RESEARCH DRIVE  
 RICHARDSON, TX 75082

MOUNTING SPECIFICATION,  
 MODERO 20.3" PANORAMIC  
 WALL TOUCH PANEL

SIZE <b>D</b>	DRAWING NUMBER SP5968-05	REV A
SCALE 1:2	SHEET 4 OF 4	