

NOTES, UNLESS OTHERWISE SPECIFIED:
 1. DIMENSIONS IN [] ARE IN MILLIMETERS

REVISIONS				
REV	ECN	DESCRIPTION	DATE	APPROVED
A	20982	INITIAL RELEASE	06/12/13	P. LE

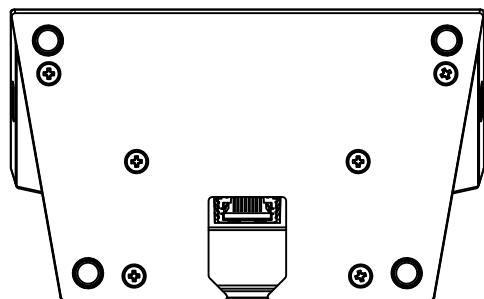
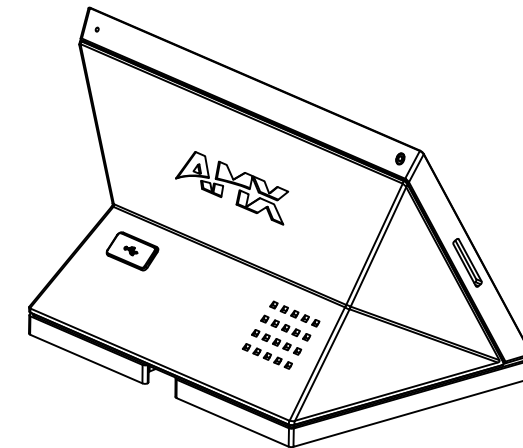
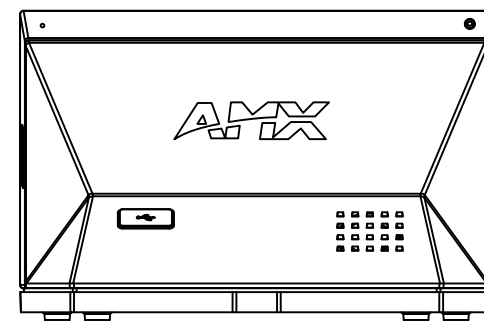
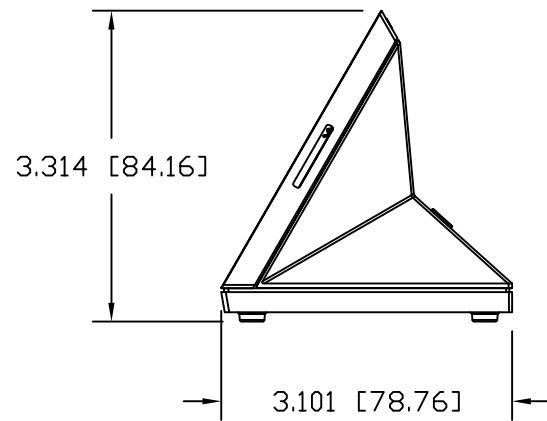
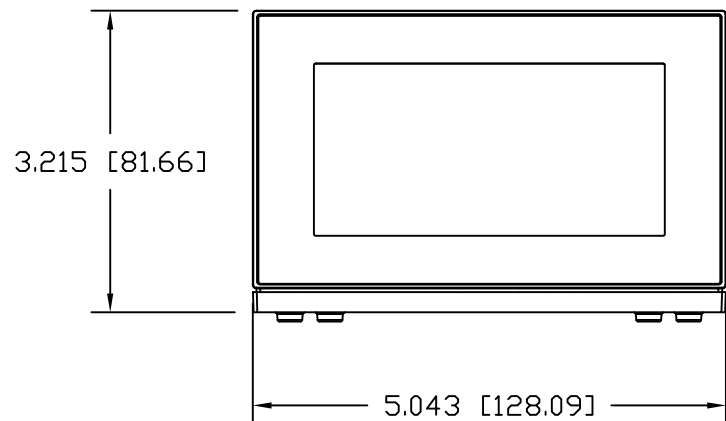
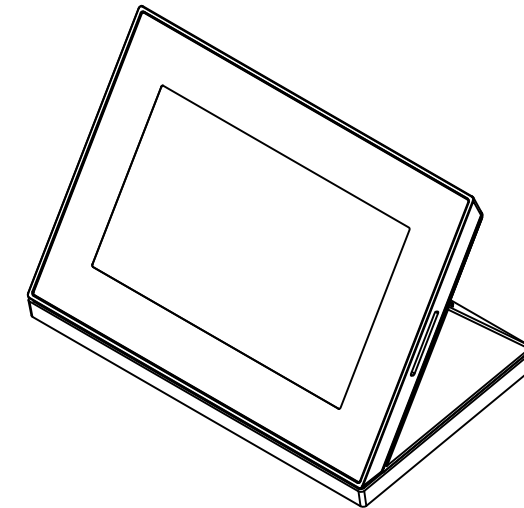
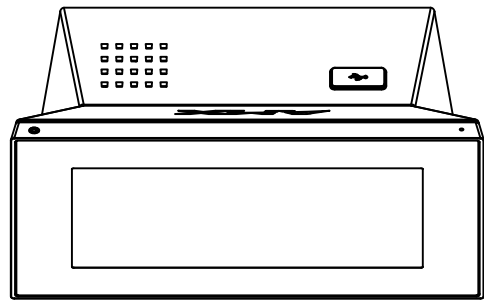

UNLESS OTHERWISE STATED, THE ARTICLE SPECIFIED SHALL BE RoHS COMPLIANT PER EU DIRECTIVE 2002/95/EC

NOTICE: This drawing is the property of AMX LLC. All information contained herein that is not generally known shall be confidential except to the extent the information has been previously established. This drawing may not be copied, reproduced, or used as the basis for manufacture or sale without written permission.

UNLESS OTHERWISE SPECIFIED

TOLERANCE ON DECIMAL DIMENSIONS: .X = ± 0.1
 .XX = ± 0.01
 .XXX = ± 0.005
 ANGLES: ± 0.5°

SURFACE FLATNESS .003 TIR PER LINEAR INCH
 ALL DIMENSIONS IN INCHES.

DO NOT SCALE DRAWING

THIRD ANGLE PROJECTION

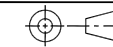

AMX LLC
 3000 RESEARCH DRIVE
 RICHARDSON, TX 75082

PICTORIAL,
 4.3 MODERO S LANDSCAPE
 TABLE TOP TOUCH PANEL

SIZE D	DWG. NO. 95-2265-07	REV. A
SCALE N/A	ACAD FILE NO. 95-2265-07_A	SHEET 1 OF 1