

Overview

The CB-MXP19/20 Rough-In Box (FG039-15) is an optional accessory for Modero X Series 19" or 20" Wall Mount Touch Panels. It allows the panel to be mounted directly to the studs/pre-wall.

The back of the Modero X Series 19" or 20" Wall Mount Touch Panel is contained within a plastic outer housing or *back box*, and the back box attaches to the Rough-In Box. The Rough-In Box kit includes a wall box, cover, and mounting screws.

Specifications

CB-MXP19/20 (FG039-15) SPECIFICATIONS	
Dimensions (HWD)	<ul style="list-style-type: none"> Rough-In Box: 8 7/8" x 14 3/8" x 2 1/4" (22.3 cm x 36.6 cm x 5.7 cm) Rough-In Box Cover Plate: 8 7/8" x 14 3/8" x 5/8" (22.3 cm x 36.6 cm x 1.5 cm)
Weight	<ul style="list-style-type: none"> With cover: TBD Without cover: 2.60 lbs (1.18kg)
Certifications	<ul style="list-style-type: none"> UL Listed
Included Accessories:	<ul style="list-style-type: none"> Cover Plate for Rough-in Box (FG039-16) Back Box to Rough-In Box Mounting Screws (4) (80-5967-03) Cover Plate to Rough-In Box Mounting Screws (4) (80-5967-03)

WARNING: In order to guarantee a stable installation of the touch panel, the distance between the CB-MXP19/20 and the outer wall surface must be a minimum of .50 inches (1.27cm) and a maximum of 1.50 inches (3.81cm).

- Refer to the 95-5968-20 diagram for detailed installation dimensions.

Pre-Wall Installation of the CB-MXP19/20 Rough-In Box

- Remove the rough-in box cover (B in FIG. 1) before installation of the Rough-In Box (A). Note: the cover MUST be removed before drywall installation. The cover may be reinstalled after drywall installation using 4-40 screws (not included).
- Fasten the CB-MXP19/20 rough-in box to the stud through the holes on the Stud Mounting tabs, using either nails or screws (not provided).
- Additional framing or blocking may be desired for a more robust mounting.
- Remove the appropriate wiring knockouts from the rough-in box to accommodate the cables being threaded through to the 19" or 20" Wall Mount Touch Panel.
- Thread the incoming Ethernet and USB wiring through the knockouts. Using the left wiring knockouts for USB connector cables and the right wiring knockouts for the LAN/PoE in cable is very highly recommended with this installation. Leave enough slack in the wiring to accommodate installation of the docking station.
- Install the drywall/sheetrock before inserting the back box for the CB-MXP19/20.
- Cut out the opening for the Wall Mount Touch Panel back box where the wall has been placed over the Rough-In Box. Cutting out the surface slightly smaller than what is outlined in the installation drawings, so that you can make any necessary cutout adjustments, is very highly recommended.

NOTE: The front cover of the CB-MXP19/20 (B in FIG. 1) should be installed after the appropriate wiring is pulled to the Rough-In Box. The cover should then be removed prior to the installation of the touch panel back box and discarded.

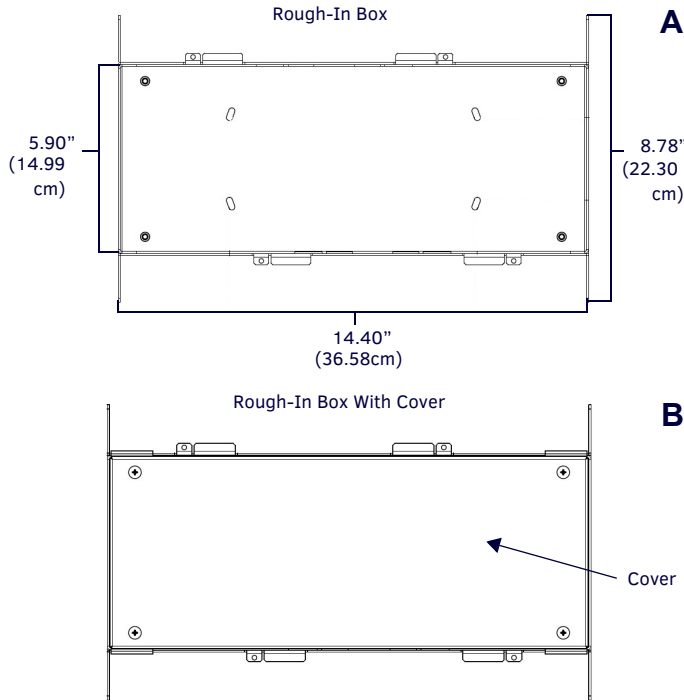
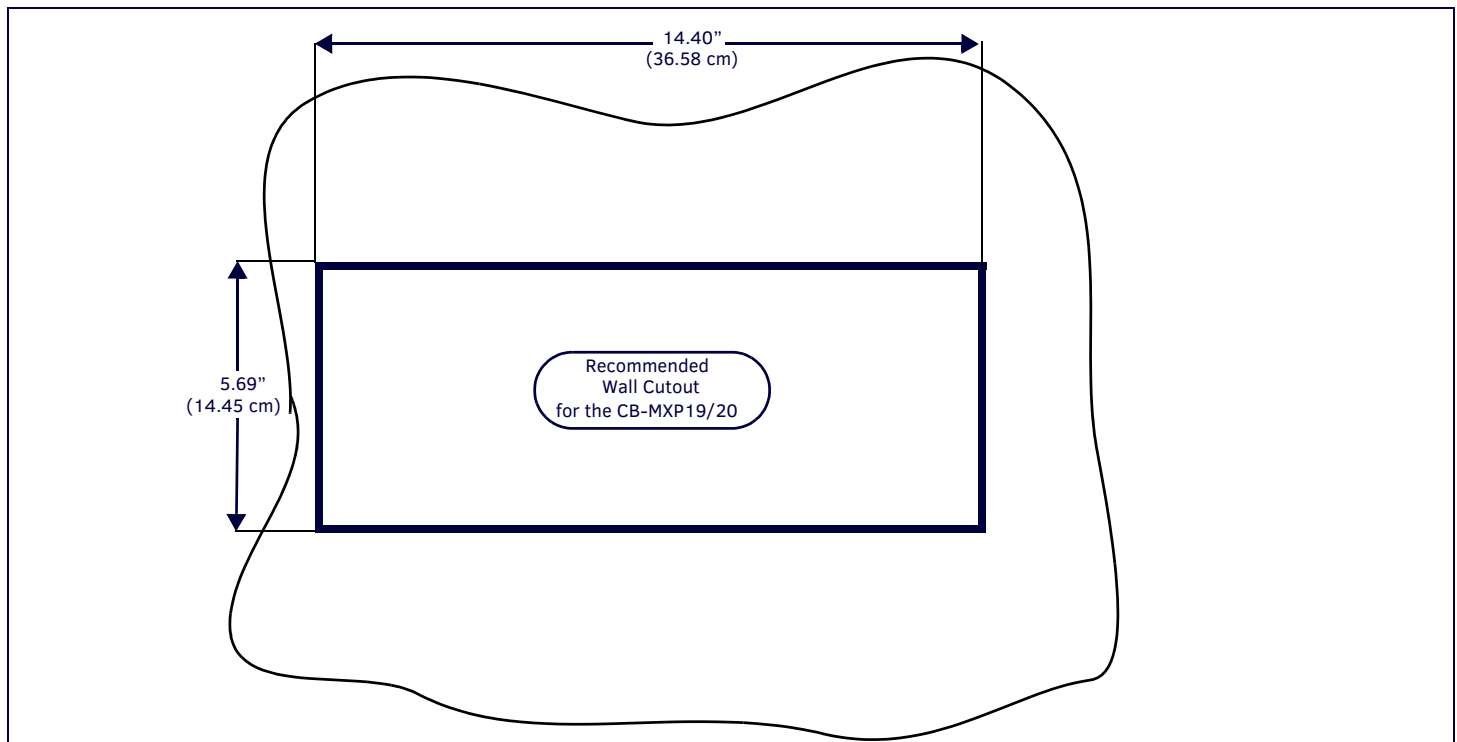
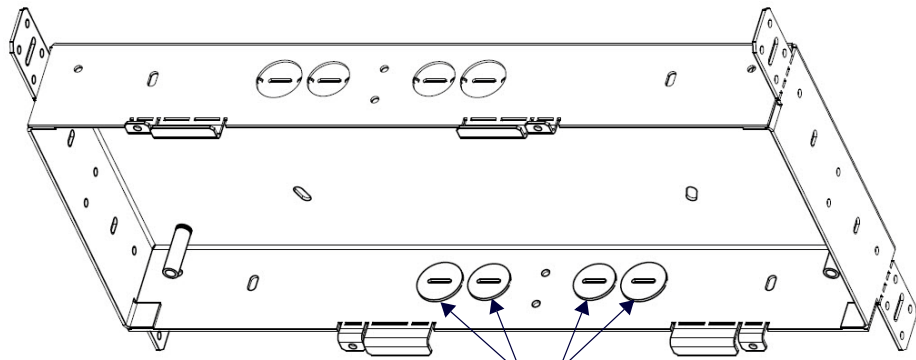
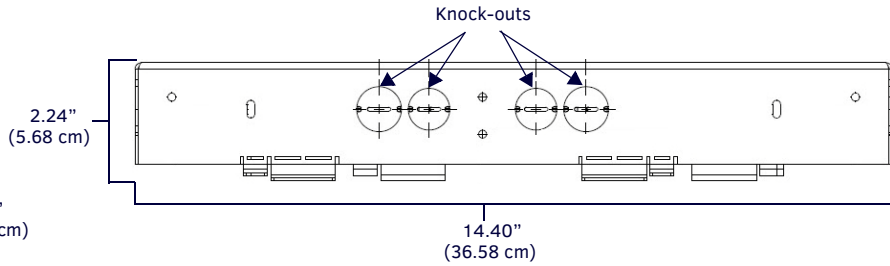
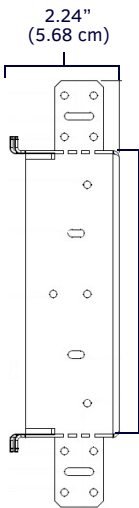

FIG. 1 CP-MXP19/20 ROUGH-IN BOX - WITH FRONT COVER





CBMXP19/20
Rough-In Box
Without Cover
(oblique angle)



Front
↓

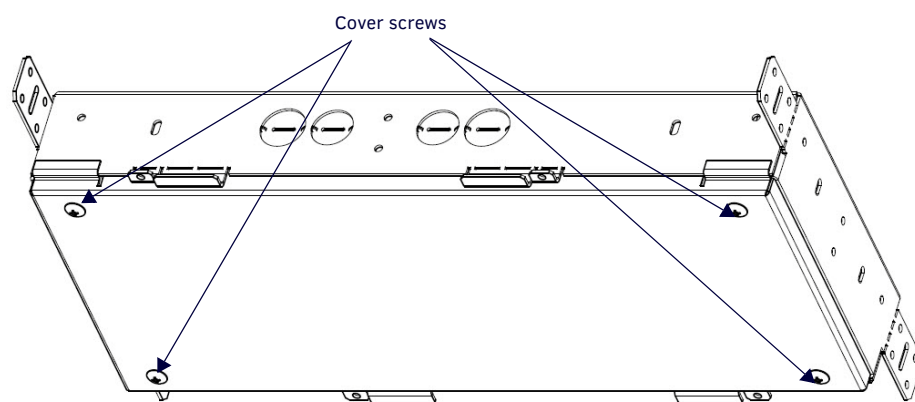

CB-MXP19/20
Rough-In Box
With Cover
(oblique angle)

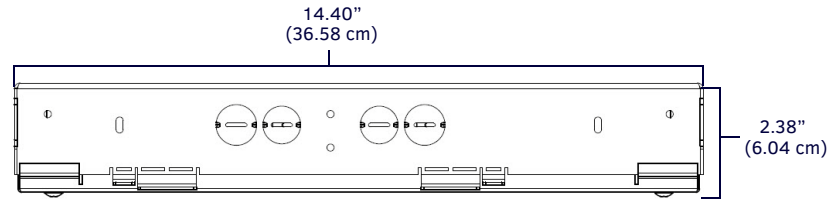
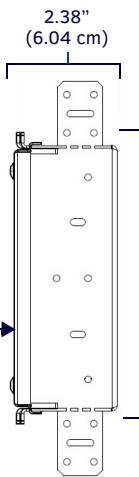

© 2015 Harman. All rights reserved. Modero, Modero X Series, AMX, AV FOR AN IT WORLD, and HARMAN, and their respective logos are registered trademarks of HARMAN. Oracle, Java and any other company or brand name referenced may be trademarks/registered trademarks of their respective companies.
 AMX does not assume responsibility for errors or omissions. AMX also reserves the right to alter specifications without prior notice at any time. The AMX Warranty and Return Policy and related documents can be viewed/downloaded at www.amx.com.
3000 RESEARCH DRIVE, RICHARDSON, TX 75082 AMX.com | 800.222.0193 | 469.624.8000 | +1.469.624.7400 | fax 469.624.7153
AMX (UK) LTD, AMX by HARMAN - Auster Road, Clifton Moor, York, YO30 4GD United Kingdom • +44 1904-343-100 • www.amx.com/eu/

93-0039-15 REV: E

